

Video over IP Controller



User Manual

VER 1.0

Thank you for purchasing this product

For optimum performance and safety, please read these instructions carefully before connecting, operating or adjusting this product. Please keep this manual for future reference.

Surge protection device recommended

This product contains sensitive electrical components that may be damaged by electrical spikes, surges, electric shock, lightning strikes, etc. Use of surge protection systems is highly recommended in order to protect and extend the life of your equipment.

Table of Contents

1. Introduction.....	1
2. Features.....	1
3. Package Contents.....	1
4. Specifications.....	2
5. Operation Controls and Functions.....	2
5.1 Front Panel.....	2
5.2 Rear Panel.....	3
5.3 IR Pin Definition.....	4
6. Rack Mounting Instruction.....	4
6.1 6U Rack Mounting.....	4
6.2 1U Rack Mounting.....	6
7. Web GUI User Guide.....	7
7.1 Preparation before Entering the System.....	7
7.2 Functions and Operation.....	11
8. Application Example.....	23

1. Introduction

This Video over IP Controller is used to control and manage H.264/H.265 IP products. It supports dual 100M network ports, which can realize dual-network isolation of Control network and Multicast video distribution network. Built-in Web GUI, TCP and RS-232 control are supported. It supports POE function and wide-band 12V IR signal receiving. Since the demand of IP products is daily increased in the current market, the IP Controller will be widely applied in more and more different scenarios.

2. Features

- ☆ Easy to create project, control and manage the system
- ☆ HTTPS, SSH security compatible
- ☆ Built-in Web GUI control interface, supporting Drag & Drop operations
- ☆ Support image preview
- ☆ Support video, audio, RS-232, IR, KVM control and management of the distributed system
- ☆ Dual network ports (VIDEO LAN port supports POE function) to isolate Controls and Multicast networks.
- ☆ Support LAN/RS-232 port control and third-party central control
- ☆ Support IR signal receiving (3.5mm audio jack, 12V level)
- ☆ 4 channel GPIO control ports (5V/12V optional level)
- ☆ Multiple circuits protection, lightning protection and ESD design
- ☆ Reliable system design, ensuring 7*24 hours reliable and stable work

3. Package Contents

- ① 1 x Video over IP Controller
- ② 1 x 20kHz-60kHz 12V IR Receiver Cable (1.5 meters)
- ③ 1 x 3-pin 3.81mm Phoenix Connector (Male)
- ④ 1 x 6-pin 3.81mm Phoenix Connector (Male)
- ⑤ 2 x Mounting Ears
- ⑥ 4 x Machine Screws (KM3*6)
- ⑦ 1 x 12V/1A Locking Power Adaptor
- ⑧ 1 x User Manual

4. Specifications

Technical	
Network Bandwidth	100M
Transmission Distance	100m CAT 5E/6/6A/7
Control Ports	2 x 100M LAN [RJ45 connector] [VIDEO LAN support POE] 1 x IR IN [3.5mm audio jack, 12V level] 1 x DIGITAL I/O [6-pin 3.81mm phoenix connector] 1 x RS-232 [3-pin 3.81mm phoenix connector]
Dimensions	204mm(W)×98mm(D)×21mm(H)
Housing	Metal Enclosure
Color	Black
Weight	509g
Power Supply	12V/1A
Power Consumption	4.5W
Operating Temperature	0°C ~ 40°C / 32°F ~ 104°F
Storage Temperature	-20°C ~ 60°C / -4°F ~ 140°F
Relative Humidity	20~90% RH (non-condensing)

5. Operation Controls and Functions

5.1 Front Panel

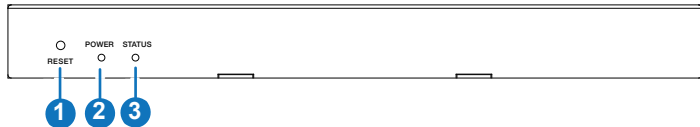

No.	Name	Function Description
1	RESET Button	Press and hold this button (about 10 seconds) until Status LED starts flashing, Controller will be reset automatically.
2	POWER LED	The red LED will light on when the Controller is powered on.
3	STATUS LED	The status LED will flash in yellowish-green every 1 second until Controller boots up completely and Control LAN is ready, then it becomes solid.

5.2 Rear Panel

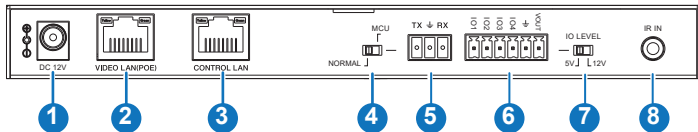

No.	Name	Function Description
1	DC 12V	DC 12V/1A power input port.
2	VIDEO LAN (POE)	100M Video LAN port, supporting POE function. <i>Note: When POE is enabled, DC 12V/1A power supply is not required.</i>
3	CONTROL LAN	The TCP/IP control network port.
4	MCU/Normal DIP Switch	Normal mode (Default): The RS-232 port is used for serial port commands control. MCU mode: The RS-232 port is used for MCU software upgrade.
5	3-pin Phoenix Connector	RS-232 serial communication port.
6	6-pin Phoenix Connector	4 channel I/O level outputs, 1 channel grounding, 1 channel power supply to the outside.
7	IO LEVEL DIP Switch	Used to control I/O level output and VOUT voltage. Switch to left: 5V I/O level output, VOUT is 5V. Switch to right: 12V I/O level output, VOUT is 12V.
8	IR IN	12V IR signal input port.

5.3 IR Pin Definition



IR RECEIVER

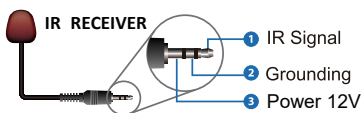

6. Rack Mounting Instruction

6.1 6U Rack Mounting

This Controller can be mounted in a standard 6U rack (Please contact your supplier for 6U rack sale). The mounting steps are as follows:

Step 1: Use included screws to fix two mounting ears on the Controller, as shown in the figure below:

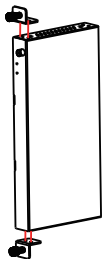

Step 2: Insert the Controller with mounting ears into a 6U rack (up to 10 units can be installed vertically), as shown in the figure below:

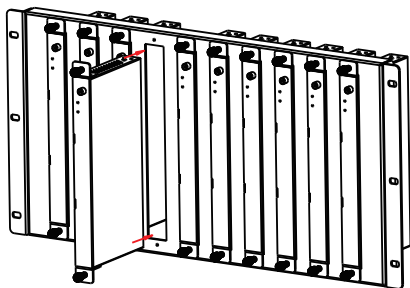

Step 3: Use screws to fix mounting ears on the rack to complete the mounting, as shown in the figure below:

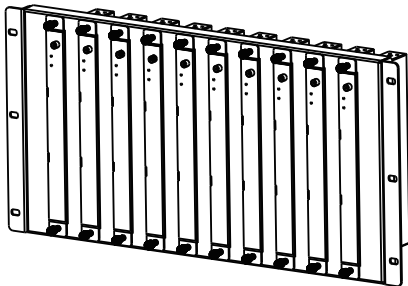

6.2 1U Rack Mounting

This Controller also can be mounted in a standard 1U rack (up to 4 units can be installed horizontally). The mounting steps are as follows:

Step 1: Stack two Controllers on top of each other, then use included screws to fix two 1U rack panels on the Controllers, as shown in the figure below:

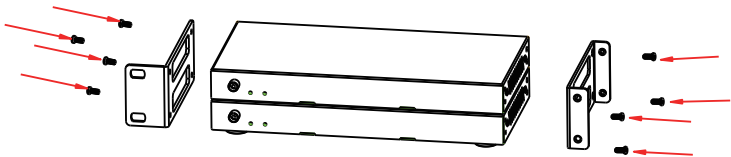

Step 2: Fix two 1U rack panels on another two stacked Controllers in the same way, then use screws to fix two 1U rack panels together, as shown in the figure below:

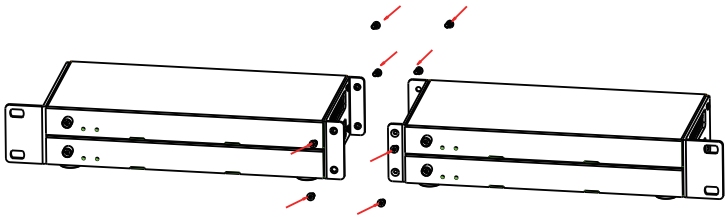

Step 3: Fasten screws between two 1U rack panels, so that four Controllers are mounted in a 1U rack, as shown in the figure below:

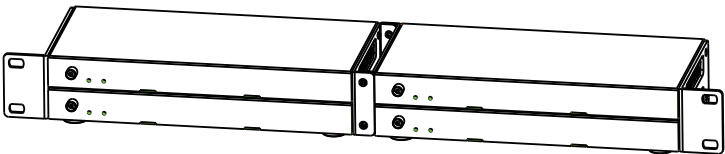

7. Web GUI User Guide

7.1 Preparation before Entering the System

You can use Controller's Web GUI to control all IP products at the Switch. The operation method is shown as below:

Step 1: Input the Controller's default IP address (192.168.0.225) or the URL (http://controller.local) into the Web browser address bar on the PC to enter the Web GUI login interface.



Select the initial username (admin) and input the initial password (1234) on the above login interface. Then, click “Log In” to enter the Web GUI interface. For the first time, you need to setup the project, as shown in the following figure:

Welcome to AV over IP system setup guide. It leads you to create the system easily by following steps.

You can click the [Close] button to load an existing project in web page directly.

Close

Next

Step 2: Click the “Close” button to load an existing project in web page directly, or click “Next” button to go to the next step.

To setup AV over IP system, you need to set the IP management mode of the Video LAN domain. The IP management modes are:

- **Automatically managed by Controller Box.**
This is the mode as factory default. The IP address assignments to Controller Box Video LAN, Encoders and Decoders will be managed by Controller Box firmware automatically. In this mode, there is no need to add router in the system on Video LAN domain.
- **DHCP mode.**
This is the mode for system in which there is a DHCP router on Video LAN domain to assign IP addresses for Controller Box Video LAN, Encoders and Decoders. The router acts as a DHCP server. It's recommended to set the net mask of router to 255.255.0.0.
- **Static IP mode by manual settings.**
This is the mode for system in case IP address resources can be assigned manually for Controller Box Video LAN, Encoders and Decoders. Reminders as below:
 - a. The network settings of Controller Box Video LAN, Encoders and Decoders must be on the same subnet.
 - b. It's recommended to set the net mask of Controller Box Video LAN, Encoders and Decoders to 255.255.0.0.

Back Next

Step 3: Select “Automatically managed by Controller Box” as the IP mode of Video LAN. (The other two modes are reserved items and are not currently available.) Then, please connect all the devices according to the following diagram.

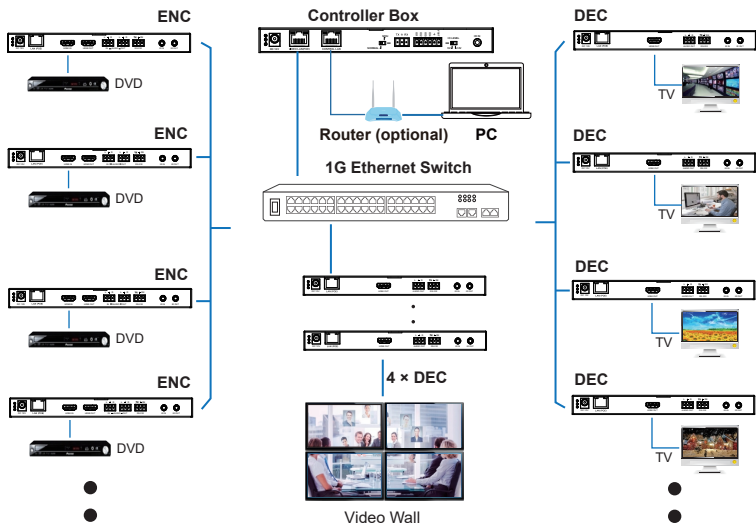

Step 4: Click the “Next” button and wait for the completion to enter the interface as shown in the figure below.

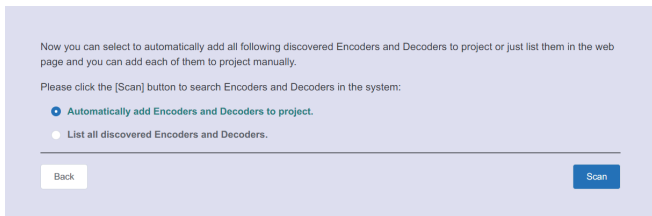

- If you select “Automatically add Encoders and Decoders to project”, and click the “Scan” button to enter the Project page. All the connected devices will be listed in the Current Devices list.

AVoIP Project

Current Devices Display ID Save Project Load Project Clear Project

Encoders				Decoders			
ID	Name	IP Address	Status	ID	Name	IP Address	Status
1	TX1	199.254.3.1	Online	1	RX1	199.254.6.1	Online
2	TX2	199.254.3.2	Online	2	RX2	199.254.6.2	Online

Unassigned Devices Assign New Devices Start Scan & Auto Assign Scan Once

Unassigned Encoders IP Address MAC Address Unassigned Decoders IP Address MAC Address

Then click “Start Scan & Auto Assign” to stop search.

- If you select “List all discovered Encoders and Decoders”, and click the “Scan” button to enter the Project page. All the connected devices will be listed in the Unassigned Devices list.

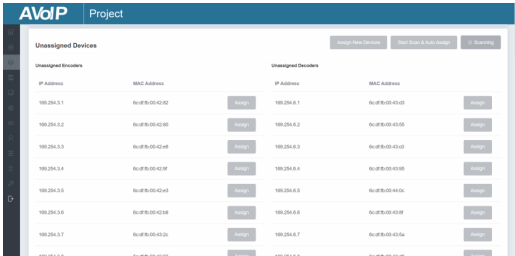

After scanning is complete, the “Assign” buttons behind Unassigned Encoders and Unassigned Decoders in the figure below will become operable.

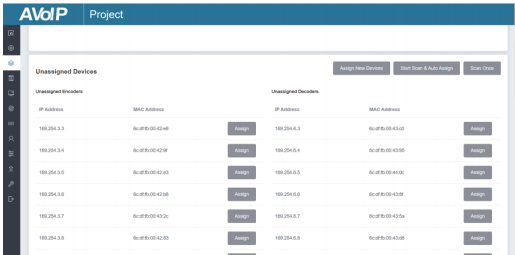

At this time, you can click the “Assign” button behind each unregistered Encoder or Decoder to add the device to the project one by one. Encoders and Decoders that have been added to the project will appear in the Current Devices list, as shown in the figure below.

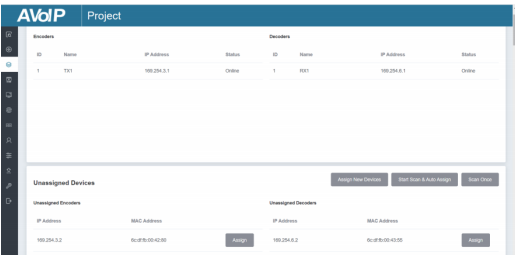

7.2 Functions and Operation

■ Preview Page

On this page, you can preview the Encoder/Decoder by clicking the drop-down list on the right side.

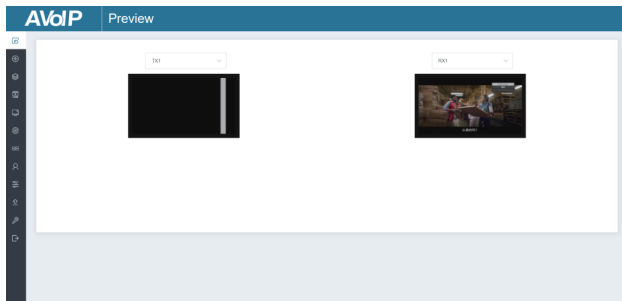

■ Matrix Control Page

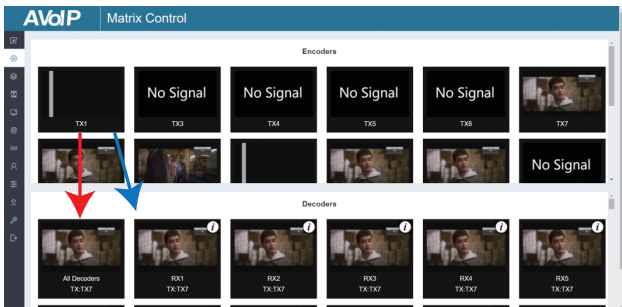

① **Encoders:** Display all the current Encoders. The text in the figure is the name of the device.

② **Decoders:** Display all the current Decoders. The text on the first line is the name of the Decoder, and the text on the second line refers to the Encoder where the signal resource is from.

Operating Instructions:

- (1) If an Encoder shows “No Signal”, it means that the Encoder cannot be dragged.
- (2) If there is an image on an Encoder, it means that the Encoder can be dragged. As shown in the figure above, if an Encoder is dragged to the place where the red arrow points to, all Decoders will share the same signal resource from this Encoder; if an Encoder is dragged to the place where the blue arrow points to, only the indicated Decoder can receive signals from this Encoder.

■ Project Page

The screenshot displays the AVoIP Project Page. At the top, there is a header with the AVoIP logo and the word "Project". Below the header, there are two main sections: "Current Devices" and "Unassigned Devices".

Current Devices: This section contains two tables. The first table, "Encoders", has columns for ID, Name, IP Address, and Status. It lists two encoders: TX1 (IP: 193.254.3.1) and TX2 (IP: 193.254.3.2), both with a status of "Online". The second table, "Decoders", has columns for ID, Name, IP Address, and Status. It lists two decoders: RX1 (IP: 193.254.6.1) and RX2 (IP: 193.254.6.2), both with a status of "Online".

Unassigned Devices: This section contains two tables. The first table, "Unassigned Encoders", has columns for IP Address and MAC Address. The second table, "Unassigned Decoders", has columns for IP Address and MAC Address.

Buttons for "Display ID", "Save Project", "Load Project", and "Clear Project" are located at the top right of the "Current Devices" section. Buttons for "Assign New Devices", "Start Scan & Auto Assign", and "Scan Once" are located at the top right of the "Unassigned Devices" section.

- ① **Current Devices:** Devices that have been added to the current project.
- ② **Unassigned Devices:** Devices not added to the current project.

Operating Instructions:

- (1) Click “Display ID” to display the ID number of the Decoders.
- (2) Click “Save Project” to save the project file (config_file.json), so that you can use the saved project next time without scanning devices again.
- (3) Click “Load Project” to load the existing project in web page directly.
- (4) Click “Clear Project” to clear the current project, then you will need to setup devices again.
- (5) Click “Start Scan & Auto Assign” to search devices that do not appear in the current project; Click again to stop searching.

- (6) Click “Assign New Devices” to search new devices automatically and add to the current project.

■ Encoders Page

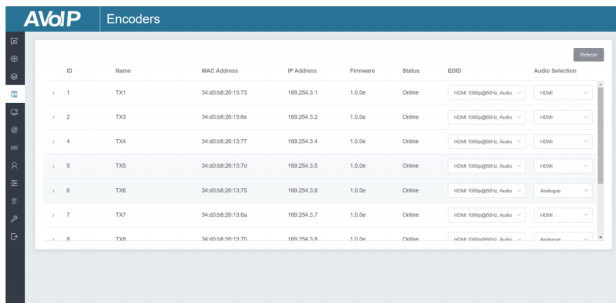

The screenshot shows the 'Encoders' page in the AVoIP interface. It features a table with columns for ID, Name, MAC Address, IP Address, Firmware, Status, EDID, and Audio Selection. There are 8 rows of data, each with a refresh icon to the left of the ID. A 'Refresh' button is located in the top right corner of the table area.

ID	Name	MAC Address	IP Address	Firmware	Status	EDID	Audio Selection
1	TX1	34-0f38-26-13-73	199.254.3.1	1.0.0e	Online	HDMI 1000g001-c, Audio	HDMI
2	TX3	34-0f38-26-13-6e	199.254.3.2	1.0.0e	Online	HDMI 1000g001-c, Audio	HDMI
4	TX4	34-0f38-26-13-77	199.254.3.4	1.0.0e	Online	HDMI 1000g001-c, Audio	HDMI
5	TX5	34-0f38-26-13-7d	199.254.3.5	1.0.0e	Online	HDMI 1000g001-c, Audio	HDMI
6	TX6	34-0f38-26-13-75	199.254.3.6	1.0.0e	Online	HDMI 1000g001-c, Audio	Analogue
7	TX7	34-0f38-26-13-6a	199.254.3.7	1.0.0e	Online	HDMI 1000g001-c, Audio	HDMI
8	TX8	34-0f38-26-13-70	199.254.3.8	1.0.0e	Online	HDMI 1000g001-c, Audio	Analogue

- ① **ID:** The ID of the current device. (Note: ID is not duplicated.)
- ② **Name:** The name of the current device. (Note: Name is not duplicated.)
- ③ **MAC Address:** The MAC Address of the current device.
- ④ **IP Address:** The IP Address of the current device.
- ⑤ **Firmware:** The Firmware version No. of the current device.
- ⑥ **Status:** The status (online or offline) of the current device.
- ⑦ **EDID:** The EDID of the current device.
- ⑧ **Audio Selection:** The Audio Selection of the current device.

Operating Instructions:

- (1) Click “Refresh” to refresh the data of the current Encoders.
- (2) Click the drop-down list of EDID to set the current Encoder’s EDID.
- (3) Click the drop-down list of Audio Selection to set the current Encoder’s audio output.
- (4) Click the icon on the left of ID to check the detail information about the current Encoder, as shown in below:

Name	<input type="text" value="TX1"/>
Update ID	<input type="text" value="Select"/>
Front Panel Power LED Flash(ON = Permanent, OFF = 90 Second time-out)	<input type="text" value="Off"/>
Power LED Flashing	<input type="text" value="Off"/>
Encoding Bandwidth	<input type="text" value="20MB"/>
Copy EDID	<input type="text" value="Select a decoder"/>
Serial Settings >	<input type="button" value="Apply"/>
Preview	
Reboot	<input type="button" value="Reboot"/>
Replace (Must be offline)	<input type="button" value="Replace (Must be offline)"/>
Remove from Project	<input type="button" value="Remove from Project"/>
Factory Default Reset	<input type="button" value="Factory Default Reset"/>

On this page, you can setup the current Encoder as required.

■ Decoders Page

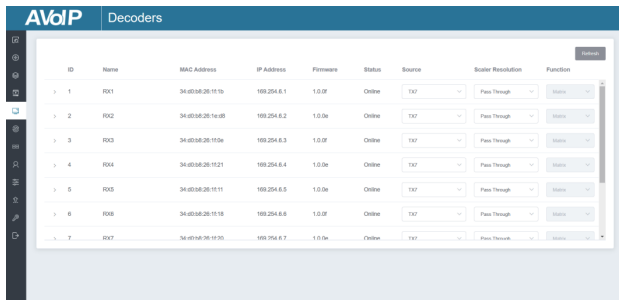

ID	Name	MAC Address	IP Address	Firmware	Status	Source	Scaler Resolution	Function
1	FX1	34-d0:08:26:11:7b	103.254.6.1	1.0.0F	Online	T&T	Pass Through	Matrix
2	FX2	34-d0:08:26:1a:08	103.254.6.2	1.0.0e	Online	T&T	Pass Through	Matrix
3	FX3	34-d0:08:26:11:0e	103.254.6.3	1.0.0F	Online	T&T	Pass Through	Matrix
4	FX4	34-d0:08:26:11:21	103.254.6.4	1.0.0e	Online	T&T	Pass Through	Matrix
5	FX5	34-d0:08:26:11:11	103.254.6.5	1.0.0e	Online	T&T	Pass Through	Matrix
6	FX6	34-d0:08:26:11:18	103.254.6.6	1.0.0F	Online	T&T	Pass Through	Matrix
7	FX7	34-d0:08:26:11:30	103.254.6.7	1.0.0e	Online	T&T	Pass Through	Matrix

- ① **ID:** The ID of the current device. (Note: ID is not duplicated.)
- ② **Name:** The name of the current device. (Note: Name is not duplicated.)
- ③ **MAC Address:** The MAC Address of the current device.
- ④ **IP Address:** The IP Address of the current device.
- ⑤ **Firmware:** The Firmware version No. of the current device.
- ⑥ **Status:** The status (online or offline) of the current device.
- ⑦ **Source:** The signal source (Encoder) of the current device.
- ⑧ **Scaler Resolution:** The resolution of the current device.
- ⑨ **Function:** The mode of the current device.

Operating Instructions:

- (1) Click "Refresh" to refresh the data of the current Decoders.
- (2) Click the drop-down list of Source to select the current Decoder's signal source.
- (3) Click the drop-down list of Scaler Resolution to select the current Decoder's resolution.
- (4) Click the drop-down list of Function to select the current Decoder's mode.
- (5) Click the icon on the left of ID to check the detail information about the current Decoder, as shown in below:

Name	<input type="text" value="RX1"/>
Update ID	<input type="text" value="Select"/>
Video Output	<input type="text" value="On"/>
Video Mute	<input type="text" value="Off"/>
Video Pause	<input type="text" value="Off"/>
Video Auto On	<input type="text" value="On"/>
Front Panel Buttons	<input type="text" value="On"/>
Front Panel IR	<input type="text" value="On"/>
Front Panel Power LED Flash(ON = Permanent, OFF = 90 Second time-out)	<input type="text" value="Off"/>
Power LED Flashing	<input type="text" value="Off"/>
Display Product ID	<input type="text" value="Off"/>
Network Routing	<input type="text" value="Multicast"/>
Rotation	<input type="text" value="0°"/>
Serial Settings >	<input type="button" value="Apply"/>
Preview	
Reboot	<input type="button" value="Reboot"/>
Replace (Must be offline)	<input type="button" value="Replace (Must be offline)"/>
Remove from Project	<input type="button" value="Remove from Project"/>
Factory Default Reset	<input type="button" value="Factory Default Reset"/>

On this page, you can setup the current Decoder as required.

■ Locked Signal Routing Page

ID	Name	IP Address	Video/Audio	RS	Serial	USB
1	R0X1	100.254.6.1	Follow	Follow	Follow	Follow
2	R0X2	100.254.6.2	Follow	Follow	Follow	Follow
3	R0X3	100.254.6.3	Follow	Follow	Follow	Follow
4	R0X4	100.254.6.4	Follow	Follow	Follow	Follow
5	R0X5	100.254.6.5	Follow	Follow	Follow	Follow
6	R0X6	100.254.6.6	Follow	Follow	Follow	Follow
7	R0X7	100.254.6.7	Follow	Follow	Follow	Follow

On this page, you can independently route the different signals between Encoder & Decoder devices. Please click “Locked Routing Help” for details.

■ Video Wall Management Page

ID	Name	Vertical	Horizontal
1	Video Wall 1	9	9

Video Wall Name	Configuration Name	Class Name	Configuration Source
Video Wall 1	Configuration 1	Class A	TX1

On this page, you can create and configure video wall as required. Please follow below steps to create a video wall.

Step 1: Click “Create”, a pop-up window will be shown as below:

Create a new Video Wall



Video Wall ID: 1

Name: Video Wall 1

Horizontal: 3

Vertical: 3

Create

You can set the Video Wall ID, Name, Horizontal and Vertical panel numbers. Then click “Create” to create the Video Wall.

Note: Up to 9 video walls can be created.

Step 2: Select the video wall that you want to configure on the “Video Wall List”, then click “Assign Decoder” to enter the Decoder assignment page. Click each screen to select the corresponding Decoder device, then click “Apply”.

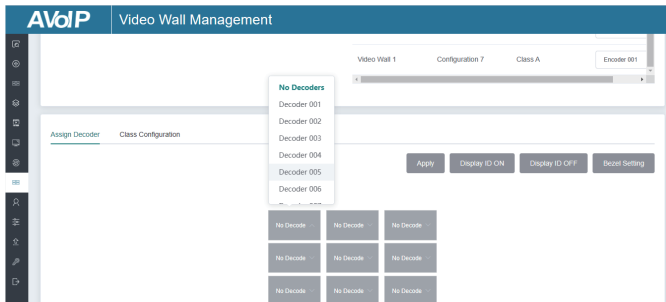

Note: A Decoder can only be assigned to one video wall.

Step 3: Click “Class Configuration” to enter the class configuration page, then click each screen to select the corresponding Class as required (the same class name will form a video wall, you can create a regular or irregular video wall by Class Configuration). Then click “Apply”.

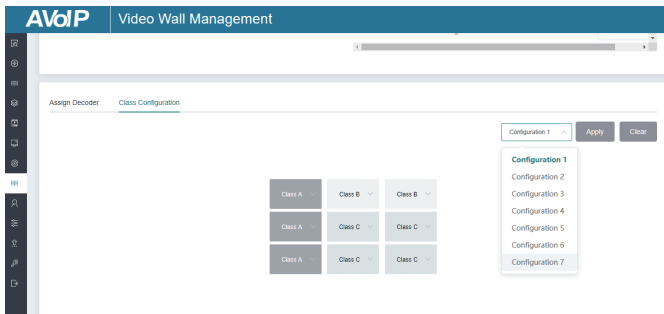

Note: Up to eight configurations can be set up for different application scenarios.

Step 4: After configuration, you can switch to “Video Wall Control” page for video preview, as shown in below.

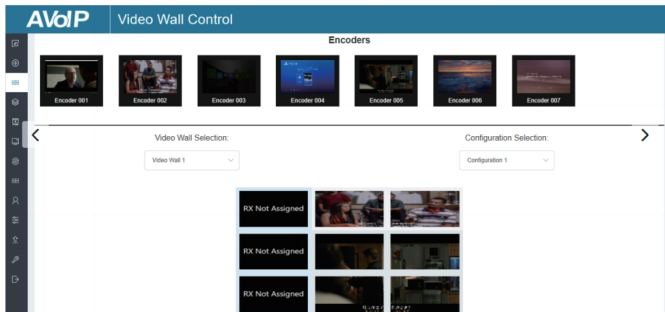

On this page, you can select different video walls and configurations that you have set up by clicking the drop-down box on the right of “Video Wall Selection / Configuration Selection”. Besides, you can directly drag Encoders at the top of the page to the video wall to change signal sources.

If you want to delete a video wall, just select the video wall on the “Video Wall List”, then click “Remove”. A prompt window will pop up and you can delete it after clicking “Yes”.

Remove Video Wall 1

×

Are you sure you want to remove Video Wall 1 from the current project?

No

Yes

The screenshot shows the AVoIP Video Wall Manager interface. At the top, there is a blue header with the AVoIP logo and the text "Video Wall Manager". A green notification banner states "The video wall has been removed from the project!". Below the header, there are two main sections: "Video Wall List" on the left and "Video Walls Information" on the right. The "Video Wall List" section contains a table with columns for ID, Name, Vertical, and Horizontal, and a "Remove" button. The "Video Walls Information" section contains a table with columns for Video Wall Name, Configuration Name, Class Name, and Configuration Sour, and a "Refresh" button. Both tables are currently empty, displaying the message "There are no video walls in the current project.".

Notes:

- (1) Each Decoder can be set into a part of a video wall array. Each system can contain multiple video walls with different sizes. Each video wall can be assigned to different screens and different layouts that range from 1x2 up to 9x9.
- (2) The controller creates and manages the video wall configurations and provides a simplified control interface and API commands to third party control system.

■ Users Page

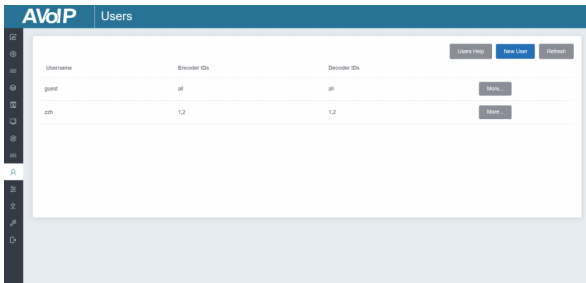

On this page, you can add new user accounts with their own control privileges. This will allow you to create a unique login and limit features such as inputs and outputs that each person has access to.

■ Controller Settings Page

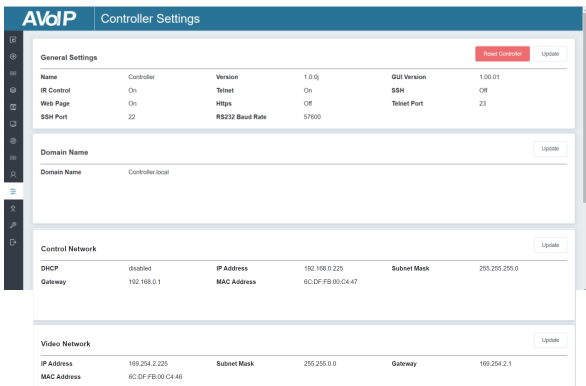

- ① **General Settings:** The basic settings of the Controller.
- ② **Control Network:** The network port configuration of the Controller connected to the Switch.
- ③ **Video Network:** The network port configuration of the Controller connected to video source devices.

You can update the settings or reset the Controller.

■ Firmware Update Page

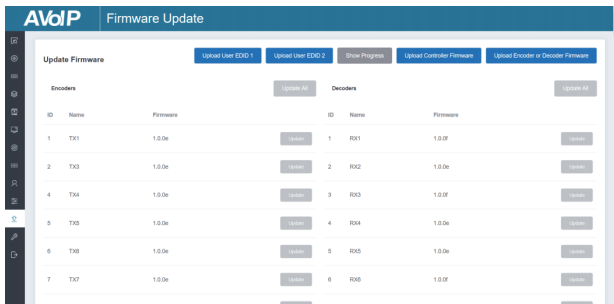

On this page, you can separately update the firmware of any Encoder/Decoder by clicking the corresponding “Update” button on the right, or update all the firmwares of Encoder/Decoder simultaneously by clicking the corresponding “Update All” button. Also you can update the Controller firmware by clicking the “Update Controller Firmware” button.

■ Password Update Page

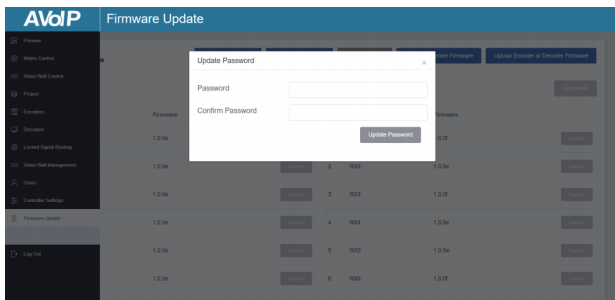

On this page, you can change the password. Note that after changing, it will skip to the Web browser home page or the Web GUI login interface automatically. You need to log in the Web GUI again with the new password.

■ Log Out Page

Click “Log Out” on the left, the Web GUI will exit and skip to the login interface automatically.

8. Application Example

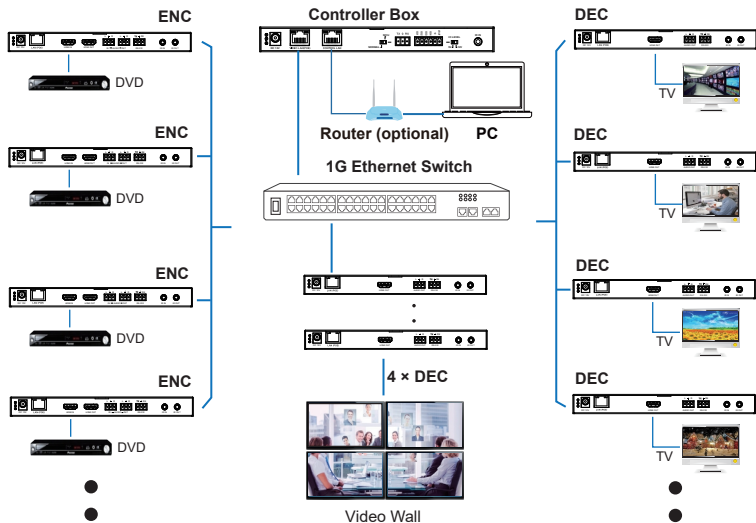

Notes:

- (1) For the default IP mode of Control LAN port of the Controller Box is DHCP, the PC also needs to be set to "Obtain an IP address automatically" mode, and an optional DHCP server (e.g. network router) is recommended in the system.*
- (2) If there is no DHCP server in the system, 192.168.0.225 will be used as the IP address of Control LAN port. You need to set the IP address of the PC to be in the same network segment. For example, set PC's IP address as 192.168.0.88.*
- (3) You can access the Web GUI by inputting URL "http://controller.local" or the Control LAN port IP address 192.168.0.225 (in case of no optional Router) on your computer's browser.*
- (4) No need to care about settings of Video LAN port of the Controller Box, as they are managed by Controller automatically (Default).*
- (5) When the Network Switch does not support POE, the Encoder, Decoder and Controller Box should be powered by DC power adapter.*