

# 2K60 over IP 100M/1GbE with Video Wall Processing



User Manual

VER 1.0

## Thank you for purchasing this product

For optimum performance and safety, please read these instructions carefully before connecting, operating or adjusting this product. Please keep this manual for future reference.

## Surge protection device recommended

This product contains sensitive electrical components that may be damaged by electrical spikes, surges, electric shock, lightning strikes, etc. Use of surge protection systems is highly recommended in order to protect and extend the life of your equipment.

## Table of Contents

1. Introduction.....	1
2. Features.....	1
3. Package Contents.....	2
4. Specifications.....	2
5. Operation Controls and Functions.....	4
5.1 Encoder Panel.....	4
5.2 Decoder Panel.....	7
6. Rack Mounting Instruction.....	10
6.1 6U Rack Mounting.....	10
6.2 1U Rack Mounting.....	11
7. Encoder and Decoder Matching Settings.....	12
8. Web GUI User Guide.....	14
9. Switch Model.....	21
10. 2K60 over IP System Control.....	22
11. Classic Application Example.....	22

## 1. Introduction

This AV over IP product distributes multiple HD contents to multiple HD display devices over a 100M/1G Network Switch. It offers configurable high quality, low-bandwidth H.265/H.264 configurable compression video and supports resolution up to 1920x1200@60Hz 4:4:4. Signal transmission distance can be extended up to 328ft/100m via CAT5E/6/6A/7 cable. Encoder supports HDMI local loop output. The product supports analog audio embedding and extracting. It also supports USB/KVM function, bidirectional IR/RS-232 control (pass-through & Guest mode) and single-machine control (without a Controller Box, matrix switching can be realized with panel buttons, local IR or RS-232 control).

## 2. Features

- ☆ HDMI 1.3 and HDCP 1.4 compliant
- ☆ Video resolution up to 1920x1200@60Hz 4:4:4
- ☆ Support 4.95Gbps video bandwidth
- ☆ Signal transmission distance can be extended up to 328ft / 100m via CAT5E/6/6A/7 cable
- ☆ Support point-to-point signal extension
- ☆ Support signal distribution, multicast mode, distributed matrix and video wall (up to 9 x 9) functions over a 1G Network Switch
- ☆ Intelligent video wall management makes it achievable of novel layout of wall configurations
- ☆ Support LPCM 2.0CH (32/44.1/48KHz) audio format
- ☆ Encoder supports HDMI local loop output
- ☆ Support audio embedding and extracting
- ☆ Support USB/KVM function (one to one & one to many), and bidirectional IR/RS-232 control (pass-through & Guest mode)
- ☆ Support main stream and sub stream encoding modes
- ☆ Stream parameters can be configured via Web GUI or Controller Box
- ☆ Controlled via panel buttons, IR, RS-232, TCP/IP, Web GUI and Controller Box
- ☆ Support POE function (802.3af Class 3, PD mode)
- ☆ Smart networking design for easy and flexible installation

### 3. Package Contents

Qty	Item
1	2K60 over IP 100M/1GbE Encoder
3	3-pin Phoenix Connector (3.81mm, male)
1	IR Blaster Cable (1.5 meters)
1	IR Receiver Cable (1.5 meters)
4	Machine Screw (KM3, 4mm)
2	Mounting Ear
1	12V/1A Locking Power Adapter
1	User Manual

or

Qty	Item
1	2K60 over IP 100M/1GbE Decoder
2	3-pin Phoenix Connector (3.81mm, male)
1	IR Blaster Cable (1.5 meters)
1	IR Receiver Cable (1.5 meters)
4	Machine Screw (KM3, 4mm)
2	Mounting Ear
1	12V/1A Locking Power Adapter
1	User Manual

### 4. Specifications

Technical	
HDMI Compliance	HDMI 1.3
HDCP Compliance	HDCP 1.4
Video Bandwidth	4.95Gbps
Video Compression Standard	H.265/H.264
Transmission Distance	100m (CAT5E/6/6A/7)
IR Level	12Vp-p
IR Frequency	Wideband 20 k - 60 KHZ
Video Resolution	Up to 1920x1200@60Hz 4:4:4
Color Space	RGB4:4:4, YCbCr 4:4:4, YCbCr 4:2:2
Color Depth	Input: 8-bit, 10-bit, 12-bit (1080p@60Hz); Output: 8-bit
Audio Formats	LPCM 2.0CH (32/44.1/48KHz)

<b>Connection</b>	
Encoder	1x HDMI IN [Type A, 19-pin female] 1x HDMI OUT [Type A, 19-pin female] 1x AUDIO IN [3-pin phoenix connector] 1x AUDIO OUT [3-pin phoenix connector] 1x RS-232 [3-pin phoenix connector] 1x LAN [RJ45 connector, POE] 1x IR IN [3.5mm audio jack, 12V IR] 1x IR OUT [3.5mm audio jack, 12V IR] 1x USB Host [Type B, 4-pin female] 2x USB Devices [Type A, 4-pin female]
Decoder	1x HDMI OUT [Type A, 19-pin female] 1x LAN [RJ45 connector, POE] 1x AUDIO OUT [3-pin phoenix connector] 1x RS-232 [3-pin phoenix connector] 1x IR IN [3.5mm audio jack, 12V IR] 1x IR OUT [3.5mm audio jack, 12V IR] 2x USB Devices [Type A, 4-pin female]
<b>Mechanical</b>	
Housing	Metal enclosure
Color	Black
Dimensions	Encoder / Decoder: 204mm [W] x 95mm [D] x 21.5mm [H]
Weight	Encoder: 472g, Decoder: 468g
Power Supply	Input: AC100 - 240V 50/60Hz, Output: DC 12V/1A
Power Consumption	Encoder: 4.08W, Decoder: 2.76W
Operating Temperature	14 - 113°F / -10 - 45°C
Storage Temperature	-4 - 140°F / -20 - 60°C
Relative Humidity	20 - 90% RH (no condensing)

# 5. Operation Controls and Functions

## 5.1 Encoder Panel

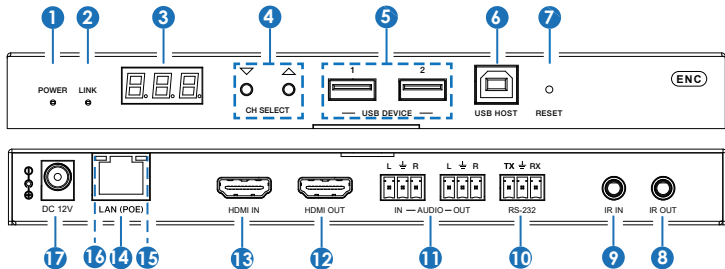

No.	Name	Function Description
1	POWER LED (Red)	The LED flashes at 1 Hz during the system startup, and the LED is always on after the startup is complete.
2	LINK LED (Green)	Network connection status LED. <ul style="list-style-type: none"><li>▪ Light on: Network is connected well, and there is compatible signal (the resolution is less than 1920*1200, and the frame rate is less than or equal to 60) access.</li><li>▪ Light flashes at 1Hz: Network is connected well, but there is not video input.</li><li>▪ Light flashes at 10Hz: Network is connected well, but the accessed signal is incompatible (resolution is greater than 1920*1200, or the frame rate is greater than 60).</li><li>▪ Light off: Network is not connected.</li></ul>
3	LED screen	Displays IP address, ID etc information. <i>Note: When clicking the SHOW ME option of the corresponding machine on the Controller, the LED screen of the corresponding machine will flash "SHO", so that you can find the corresponding machine in the system.</i>
4	CH SELECT	Used to set Encoder ID and other settings.
5	USB DEVICE	Connect to Key or Mouse.
6	USB HOST	USB-B connector for connecting a PC as KVM function.
7	RESET	System reset button. Press and hold this button for 5 seconds, the system will restart and restore factory settings.
8	IR OUT	IR signal output port.

9	IR IN	12V IR signal input port.
10	RS-232	RS-232 serial port, supporting signal pass-through and local serial port control.
11	IN-AUDIO-OUT	AUDIO IN: Analog stereo audio input port. Connect to an audio input source device.
		AUDIO OUT: Analog stereo audio output port. Connect to an audio output device.
12	HDMI OUT	HDMI local loop output port, connect to an HDMI display device such as TV or monitor.
13	HDMI IN	HDMI input port, connect to an HDMI source device such as DVD or Set-top box with an HDMI cable.
14	LAN (POE)	100M/1G Network port. Connect to a Switch/Router/Hub for data transmission or POE function.
15	Link Signal Indicator lamp (Green)	<ul style="list-style-type: none"> <li>▪ Illuminating: The network cable is connected normally.</li> <li>▪ Dark: The network cable is not connected well.</li> </ul>
16	Data Signal Indicator lamp (Yellow)	<ul style="list-style-type: none"> <li>▪ Flashing: There is data transmission.</li> <li>▪ Dark: There is no data transmission.</li> </ul>
17	DC 12V	<p>The device can be powered via two methods:</p> <ul style="list-style-type: none"> <li>▪ Local DC 12V/1A power supply</li> <li>▪ POE from Network Switch. Device acts as PD mode. When the Switch supports POE function, DC power supply is not needed.</li> </ul>

**Notes:**

*Encoder can choose HDMI audio input or external audio embedding. It can be set through the CH SELECT buttons on the front panel of the Encoder. (The default setting is HDMI audio input.)*

*If it is set to HDMI audio input, the L/R OUT output of Encoder is HDMI audio loop out. If it is set to external audio embedding, the L/R IN input of Encoder is the input of external audio embedding, and the L/R OUT output is the external audio embedding loop out.*

**Description of the LED screen and CH SELECT buttons (For the Encoder).**

- 1, After the system is powered on, the Encoder's LED screen will show the ENC ID (000 by default if not set).
- 2, Press and hold the UP button for 5 seconds, the Encoder's LED screen will show in sequence "IP:", "xxx", "xxx", "xxx", "xxx", which is the IP address of the Encoder.
- 3, Press and hold UP + DOWN buttons at the same time for 5 seconds, then release to enter the "Configuration" mode with "CFN" displaying on the LED screen.

- 4, For Channel ID settings, press the UP or DOWN button to display the current ID number (e.g. 001) on the LED screen. Press and hold UP + DOWN buttons for 5 seconds, then release to enter the "ID Settings" mode. The ID number (e.g. 001) on the LED screen will flash at 1Hz, then press the UP or DOWN button to select the Channel ID you desired, then press and hold UP + DOWN buttons for 5 seconds to confirm the setting and stop flashing.
- 5, For EDID ID settings, press the UP or DOWN button until the LED screen shows "E00" (in which "E" refers to EDID, "00" to EDID ID). Press and hold UP + DOWN buttons for 5 seconds, then release to enter the "EDID Settings" mode. The EDID ID number (e.g. E01) on the LED screen will flash at 1Hz, then press the UP or DOWN button to select the EDID ID you desired, then press and hold UP + DOWN buttons for 5 seconds to confirm the setting and stop flashing.  
The corresponding EDID ID is as follows:

EDID ID	EDID Description
00	H1080P60_2CH
01	H720P60_2CH
02	D1024P60
03	D1080P60
04	D1200P60
05	H1200P60_2CH
06	COPY
07	USER1
08	USER2

**Notes:**

- (1) *H refers to HDMI; D refers to DVI. (The default EDID of 1080p60 will be used if you have not previously copied the EDID to ID 06 or downloaded EDID to ID 07/08 on the controller box web page.)*
  - (2) *EDID ID 06/07/08 is not available without Controller Box.*
- 6, For audio options settings, press the UP or DOWN button until the LED screen shows "AHE" (in which "A" refers to Audio and "HE" to HDMI EMB). Press and hold UP + DOWN buttons for 5 seconds, then release to enter the "AUDIO Settings" mode. The audio option (AHE or AEI) on the LED screen will flash at 1Hz, then press the UP or DOWN button to select the AUDIO option, then press and hold UP + DOWN buttons for 5 seconds to confirm the setting and stop flashing.

The corresponding audio options are as follows:

AHE: Use HDMI Audio

AEI: Use external Audio In



## 5.2 Decoder Panel

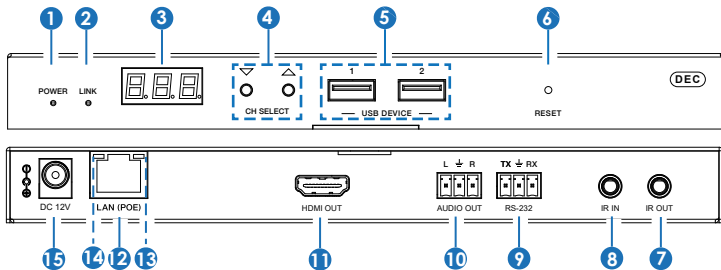

No.	Name	Function Description
1	POWER LED (Red)	The LED flashes at 1 Hz during the system startup, and the LED is always on after the startup is complete.
2	LINK LED (Green)	Network connection status LED. <ul style="list-style-type: none"> <li>Light on: Network is connected well, and there is video data.</li> <li>Light flashes: Network is connected well, but there is no video data.</li> <li>Light off: Network is not connected.</li> </ul>
3	LED screen	Displays IP address, ID etc information. <i>Note: When clicking the SHOW ME option of the corresponding machine on the Controller, the LED screen of the corresponding machine will flash "SHO", so that you can find the corresponding machine in the system.</i>
4	CH SELECT	Used to set Decoder ID and other settings.
5	USB DEVICE	Connect to Key or Mouse.
6	RESET	System reset button. Press and hold this button for 5 seconds, the system will restart and restore factory settings.
7	IR OUT	IR signal output port.
8	IR IN	12V IR signal input port.
9	RS-232	RS-232 serial port, supporting signal pass-through and local serial port control.
10	AUDIO OUT	Analog stereo audio output port. Connect to an amplifier or loudspeaker through a 3-pin phoenix connector. It follows the audio output of the Encoder.

11	HDMI OUT	HDMI output port, connect to an HDMI display device such as TV or monitor.
12	LAN (POE)	100M/1G Network port. Connect to a Switch/Router/Hub for data transmission or POE function.
13	Link Signal Indicator lamp (Green)	<ul style="list-style-type: none"> <li>▪ Illuminating: The network cable is connected normally.</li> <li>▪ Dark: The network cable is not connected well.</li> </ul>
14	Data Signal Indicator lamp (Yellow)	<ul style="list-style-type: none"> <li>▪ Flashing: There is data transmission.</li> <li>▪ Dark: There is no data transmission.</li> </ul>
15	DC 12V	<p>The device can be powered via two methods:</p> <ul style="list-style-type: none"> <li>▪ Local DC 12V/1A power supply</li> <li>▪ POE from Network Switch. Device acts as PD mode.</li> </ul> <p>When the Switch supports POE function, DC power supply is not needed.</p>

#### **Description of the LED screen and CH SELECT buttons (For the Decoder).**

- 1, After the system is powered on, the Decoder's LED screen will show the ID of the connected Encoder (000 by default if not set).
- 2, Press and hold the UP button for 5 seconds, the Decoder's LED screen will show in sequence "IP:", "xxx", "xxx", "xxx", "xxx", which is the IP address of the Decoder.
- 3, Press and hold UP + DOWN buttons at the same time for 5 seconds, then release to enter the "Configuration" mode with "CFN" displaying on the LED screen.
- 4, For Channel ID settings, press the UP or DOWN button to display the current ID number (e.g. 001) on the LED screen. Press and hold UP + DOWN buttons for 5 seconds, then release to enter the "ID Settings" mode. The ID number (e.g. 001) on the LED screen will flash at 1Hz, then press the UP or DOWN button to select the Channel ID you desired, then press and hold UP + DOWN buttons for 5 seconds to confirm the setting and stop flashing.
- 5, For output resolution settings, press the UP or DOWN button until the LED screen shows "S00" (in which "S" refers to Scaler and "00" to resolution ID), then press and hold UP + DOWN buttons for 5 seconds, then release to enter the "Output Resolution Settings" mode. The Resolution ID number (e.g. S01) on the LED screen will flash at 1Hz, then press the UP or DOWN button to select the Resolution ID you desired, then press and hold UP + DOWN buttons for 5 seconds to confirm the setting and stop flashing.

The corresponding output resolution ID is as follows:

Resolution ID	Resolution Description
00	Pass Through (default)
01	1080P60
02	1080P50
03	1080P30
04	1080P25
05	1080P24
06	720P60
07	720P50
08	576P50
09	480P60
10	640X480P60
11	800X600P60
12	1024X768P60
13	1280X800P60
14	1280X1024P60
15	1366X768P60
16	1440X900P60
17	1600X1200P60
18	1680X1050P60
19	1920X1200P60

## 6. Rack Mounting Instruction

### 6.1 6U Rack Mounting

This product can be mounted in a standard 6U rack (Please contact your supplier for 6U rack sale). The mounting steps are as follows:

**Step 1:** Use included screws to fix two mounting ears on the product, as shown in the figure below:

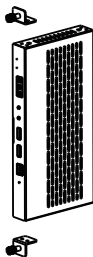

**Step 2:** Insert the product with mounting ears into a 6U rack (up to 10 units can be installed vertically), as shown in the figure below:

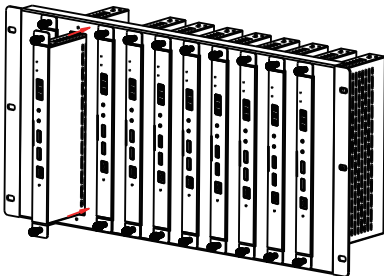

**Step 3:** Use screws to fix mounting ears on the rack to complete the mounting, as shown in the figure below:

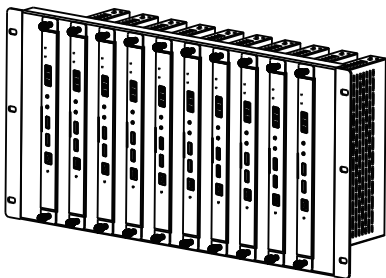

## 6.2 1U Rack Mounting

This product also can be mounted in a standard 1U rack (up to 4 units can be installed horizontally). The mounting steps are as follows:

**Step 1:** Stack two products on top of each other, then use included screws to fix two 1U rack panels on the products, as shown in the figure below:

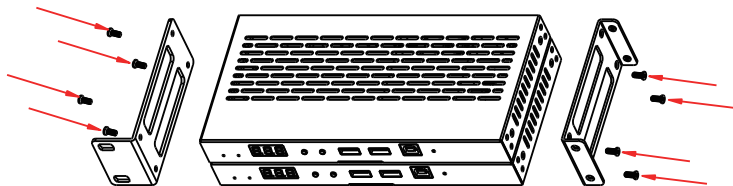

**Step 2:** Fix two 1U rack panels on another two stacked products in the same way, then use screws to fix two 1U rack panels together, as shown in the figure below:

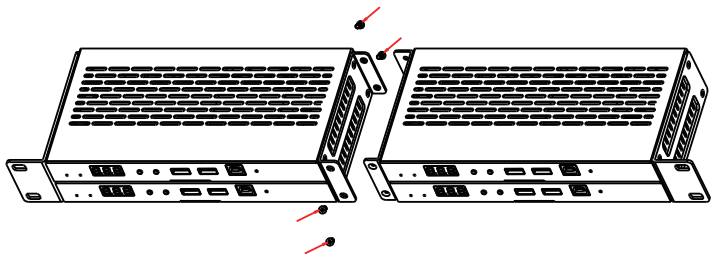

**Step 3:** Fasten screws between two 1U rack panels, so that four products are mounted in a 1U rack, as shown in the figure below:

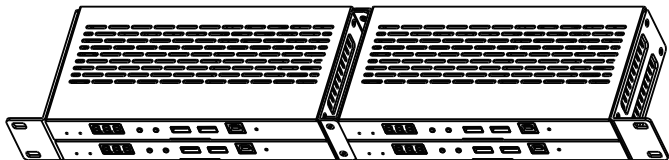

## 7. Encoder and Decoder Matching Settings

When multiple Encoders and Decoders are used in the system without a Controller Box, it is necessary to match them well firstly. You can match all Encoders and Decoders in following three methods.

**Method 1:** Use the CH SELECT buttons on the front panel of the Encoder/Decoder.

According to the methods mentioned in Chapter 5, set the ID of Encoder, then set the ID of Decoder, finally set the Encoder ID from which to subscribe the stream. Match all Encoders and Decoders in the same way.

**Method 2:** Use the RS-232 serial port command control.

Connect the RS-232 port of Encoder/Decoder to a PC or control system, as shown in the figure below. Then use a Serial Command tool on PC to send the RS-232 command code: `!OUT xxx FR yyy\r\n`. The function of this command is to connect the Decoder (ID:xxx) to the Encoder (ID:yyy). Match all Encoders and Decoders in the same way.

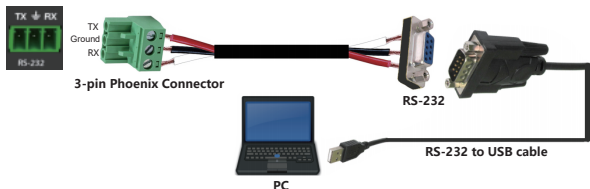

**Method 3:** Use the IR remote control (optional).

The IR of Decoder supports using IR remote control. The button number on the IR remote control is the ID of Encoder which is to be connected to the current Decoder. You can select Encoder 1~40 to match the current Decoder by directly pressing button 1~40. If you press and hold the button 1 for 5 seconds, Encoder 41~80 can be selected.



## 8. Web GUI User Guide

You can use the built-in Web GUI to configure all IP products through a Switch. The operation method is shown as below.

**Step 1:** Match all Encoders and Decoders as described in Chapter 7.

**Step 2:** Connect the PC, Encoders and Decoders you need to configure to a Switch. The connection diagram is shown as below.

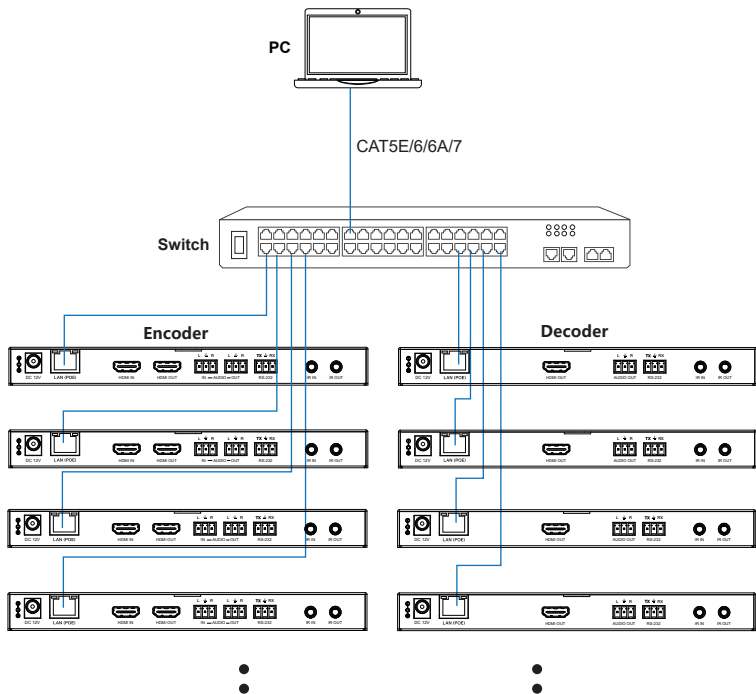



**Step 3:** Press and hold the (CH SELECT) UP button on the front panel of the Encoder/Decoder for 5 seconds to check the IP address. (Please refer to Chapter 5 for details.)

**Step 4:** Set the PC's IP address to be in the same network segment with the Encoder/Decoder, for instance, set the IP address to be 169.254.3.150 and Subnet mask to be 255.255.0.0.

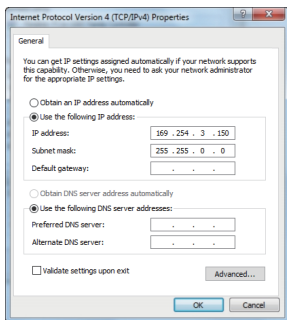
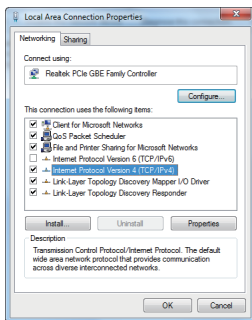

**Step 5:** Input the IP address of the Encoder/Decoder into the browser on PC to enter the Web GUI login interface.

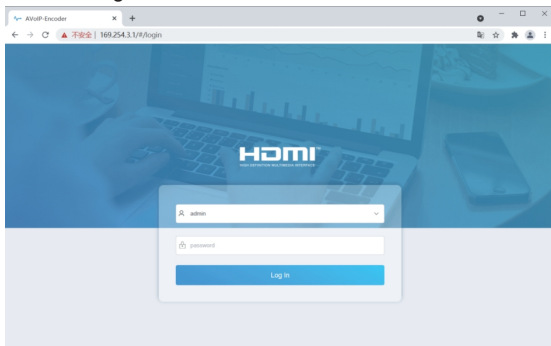

**Step 6:** Input the default User “admin” and the default Password “admin”, and then click “Log In” to enter the Web GUI interface.

The Web GUI function pages are shown as below:

## ■ Device Information Page

The Status page provides basic information about the Encoder/Decoder, such as Firmware Version, IP Address, Subnet Mask, Gateway and MAC Address.

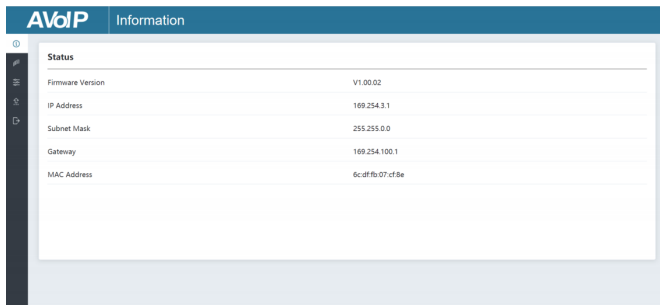

The screenshot shows the AVoIP Information page. The header includes the AVoIP logo and the word "Information". A left sidebar contains navigation icons. The main content area is titled "Status" and displays the following information:

Property	Value
Firmware Version	V1.00.02
IP Address	169.254.3.1
Subnet Mask	255.255.0.0
Gateway	169.254.100.1
MAC Address	6c:dff:fb:07:cf:8e

## ■ Video Configuration Page

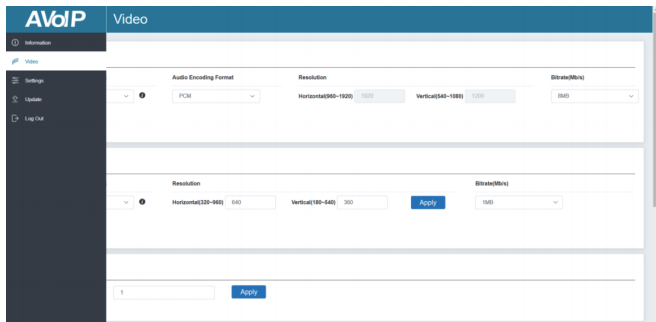

The screenshot shows the AVoIP Video configuration page. The header includes the AVoIP logo and the word "Video". A left sidebar contains navigation icons. The main content area is titled "Video" and displays the following configuration options:

**Audio Encoding Format:** PCM

**Resolution:** Horizontal(960-1920) 1080, Vertical(440-1080) 720

**Bitrate(kbps):** 5120

**Resolution:** Horizontal(320-640) 640, Vertical(180-640) 360

**Bitrate(kbps):** 1280

**Apply** button

On this page, you can configure the video properties as required.

## Encoder Video Configuration

Encoder video configuration page includes Main Stream, Sub Stream, ID Setting, Audio Selection and EDID Setting.

The screenshot displays the 'Video' configuration page for an AvVoIP device. The page is organized into five main sections:

- Main Stream:** Features three columns for configuration. The first column, 'Video Encoding Format', has a dropdown menu set to 'H.265'. The second column, 'Audio Encoding Format', has a dropdown menu set to 'PCM'. The third column, 'Resolution', shows 'Horizontal(1920-1920)' and 'Vertical(1080-1080)' with input fields for '1920' and '1080' respectively. A 'Bitrate(Mbps)' dropdown is set to '8MB'.
- Sub Stream:** Similar to the main stream, it has 'Video Encoding Format' set to 'H.265'. The 'Resolution' section shows 'Horizontal(1280-960)' and 'Vertical(1120-840)' with input fields for '960' and '840'. An 'Apply' button is present. The 'Bitrate(Mbps)' dropdown is set to '1MB'.
- ID Setting:** Contains a 'Local ID(1-768)' input field with the value '1' and an 'Apply' button.
- Audio Selection:** Features an 'Audio Input' dropdown menu set to 'HDMI'.
- EDID Setting:** Includes two 'Select User EDID File' sections, each with an 'Upload' button. Below these is an 'EDID' dropdown menu set to 'HDMI 1080p@60Hz\_Audio 2CH PCM'.

**Main Stream:** You can configure Video Encoding Format, Audio Encoding Format and Bitrate. Video Encoding Format supports H.264 and H.265 (H.265 by default). Audio Encoding Format supports PCM and AAC (PCM by default). Encoding Resolution cannot be set, it follows the input resolution. The default Bitrate is 8Mb/s.

**Sub Stream:** You can configure Video Encoding Format, Resolution and Bitrate. Video Encoding Format supports H.264 and H.265 (H.265 by default). The default Encoding Resolution is 640\*360. The default Bitrate is 1Mb/s.

**ID Setting:** You can configure the ID of the Encoder. (After setting the ID, the IP will change. You need to press and hold the (CH SELECT) UP button on the front panel of the Encoder for 5 seconds to check the IP address, and then re-enter the new IP address on the web page to continue setting).

**Audio Selection:** You can configure the Audio Input (HDMI/Analogue).

**EDID Setting:** You can choose an EDID option from the drop-down list as shown in the below figure.

**Audio Selection**

Audio Input

**EDID Setting**

Select User EDID1 File

EDID

HDMI 1080p@60Hz, Audio 2CH PCM

HDMI 720p@60Hz, Audio 2CH PCM

DVI 1280x1024@60Hz, Audio None

DVI 1920x1080@60Hz, Audio None

DVI 1920x1200@60Hz, Audio None

HDMI 1920x1200p@60Hz, Audio 2CH PCM

User EDID 1

Upload

Select User EDID2 File

Browse

Upload

HDMI 1080p@60Hz, Audio 2CH PCM

User EDID 1 and User EDID 2 can be uploaded in Select User EDID1 File and Select User EDID2 File, and the content of the uploaded binary file is EDID. (This file can be downloaded from the Download EDID of the Decoder Video page.)

## Decoder Video Configuration

Decoder video configuration page includes Transmission Protocol, Scale Setting, Download EDID, Video Timeout Setting, ID Setting and Picture Setting.

**AVoIP** Video

**Transmission**

Protocol

**Scaler Setting**

Scaler

**Download EDID**

Download EDID to your PC

**Video Timeout Setting**

Timeout After Video Lost (3-60min)

**ID Setting**

Local ID(1-762)

Max Channel ID(3-762)

Source Selection ID(1-762)

**Picture Setting**

Brightness

Contrast

Hue

Saturation

**Transmission Protocol:** You can select “udp unicast” or “udp multicast” (udp multicast by default).

**Scaler Setting:** You can set the output resolution (Pass Through by default).

**Download EDID:** You can download the EDID binary file of the display device connected to the Decoder. The EDID file can be used as the User EDID file to be uploaded to the Encoder.

**Video Timeout Setting:** You can set the timeout to turn off the video output when no input video signal is detected. 0 means never close.

### **ID Setting:**

**Local ID:** You can set the ID of the Decoder. (After setting the ID, the IP will change. You need to press and hold the (CH SELECT) UP button on the front panel of the Decoder for 5 seconds to check the IP address, and then re-enter the new IP address on the web page to continue setting).

**Max Channel ID:** You can set the maximum range of Source Selection ID that can be set. When it is set to 0, there is no limit to the setting range of Source Selection ID.

**Source Selection ID:** You can select the ID of the Encoder to be the input source.

**Picture Setting:** You can configure the picture parameters (Brightness, Contrast, Hue and Saturation).

## ■ Settings Page

On this page, you can set Network settings, configure Security Module, modify username and Login Password as required.

The screenshot shows the AVoIP Settings page. The top navigation bar is blue with the AVoIP logo on the left and the word 'Settings' on the right. Below the navigation bar is a sidebar with icons for home, settings, and help. The main content area is divided into three sections: Network, Security, and Modify username. The Network section has four input fields: IP Address (192.254.3.1), Gateway (192.254.100.1), Subnet Mask (255.255.0.0), and HTTP Web Port (80). Below these fields are two buttons: 'Set Network Defaults' and 'Save'. The Security section has a single input field for HTTPS, which is currently set to 'On'. The Modify username section has a single input field for Username and an 'Apply' button.

Login

Old Password

New Password

Confirm Password

**Notes:**

- (1) The Network Settings can be set only when the Mode button is set to Static.
- (2) All changes will take effect by clicking “Save” below.
- (3) After any changes to the Network Settings, username or Login Password, it will redirect to the Web browser home page or the Web GUI login interface. You need to log in the Web GUI again with the new settings.

■ **Update Page**

AVoIP Update

Transmitter

Firmware Update  No file chosen

Factory Reset

Reboot

Click “Browse..” to import the upgrade file and click “Update” to start upgrade. There will be a progress bar prompt during the upgrade process. When the progress bar reaches 100%, it indicates the upgrade is successful, and the device will be restarted automatically.

Clicking “Reset” can reset the device to factory default settings.

Clicking “Reboot” can reboot the device.

## ■ Log Out Page

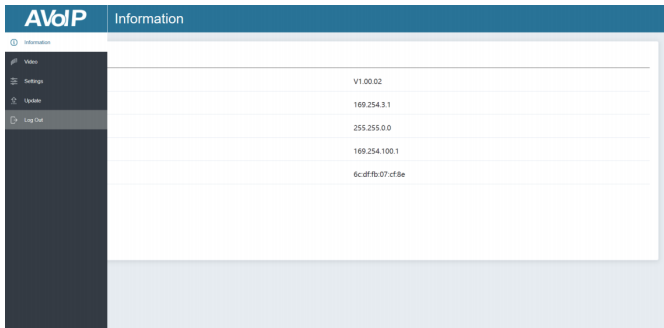

Click “Log Out” on the left, the Web GUI will exit and skip to the login interface automatically.

## 9. Switch Model

A network Switch used to set up the system should support below features:

1. Type of layer 3/managed network Switch.
2. Gigabit bandwidth.
3. Support multicast, and need to enable the multicast function.
4. Support IGMP snooping, and need to enable the IGMP snooping function.
5. Support filter/drop unregistered Multicast traffic, and need to enable the function.

The following Switch models are highly recommended.

Manufacturer	Model Number
HUAWEI	S5720S-28X-PWR-LI-AC
NETGEAR	S3300

## 10. 2K60 over IP System Control

This product also can be controlled by Controller Box or third-party controller. For details of 2K60 over IP system control, please refer to 2K60 over IP Controller Box user manual.

## 11. Classic Application Example

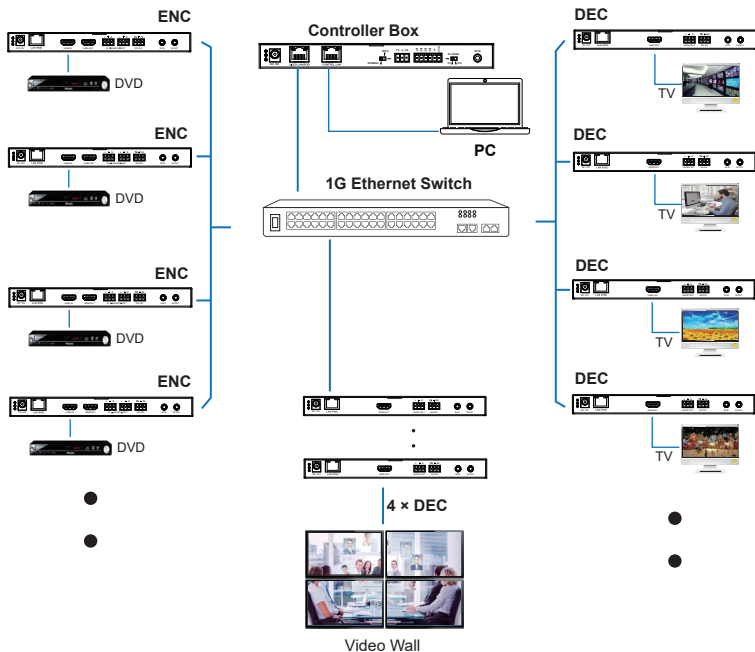



**Notes:**

- (1) For the default IP mode of Control LAN port of the Controller Box is DHCP, the PC also needs to be set to “Obtain an IP address automatically” mode, and a DHCP server (e.g. network router) is required in the system.*
- (2) If there is no DHCP server in the system, 192.168.0.225 will be used as the IP address of Control LAN port. You need to set the IP address of the PC to be in the same network segment. For example, set PC’s IP address as 192.168.0.88.*
- (3) You can access the Web GUI by inputting Control LAN port IP address (192.168.0.225) or URL “http://controller.local” on your computer’s browser.*
- (4) No need to care about settings of Video LAN port of the Controller Box, they are managed by Controller automatically.*
- (5) When the Network Switch does not support PoE, the Encoder, Decoder and Controller Box should be powered by DC power adapter.*



The terms HDMI and HDMI High-Definition Multimedia interface, and the HDMI Logo are trademarks or registered trademarks of HDMI Licensing LLC in the United States and other countries.