

18Gbps 4 x 4 HDMI Matrix (70M)



User Manual



sales@fourkay.net

0207 175 5144

Thank you for purchasing this product

For optimum performance and safety, please read these instructions carefully before connecting, operating or adjusting this product. Please keep this manual for future reference.

Surge protection device recommended

This product contains sensitive electrical components that may be damaged by electrical spikes, surges, electric shock, lightning strikes, etc. Use of surge protection systems is highly recommended in order to protect and extend the life of your equipment.

Table of Contents

1. Introduction.....	1
2. Features.....	1
3. Package Contents.....	2
4. Specifications.....	2
5. Operation Controls and Functions.....	4
5.1. Matrix Panel.....	4
5.2. CAT Receiver Panel.....	5
6. IR Remote.....	6
7. IR Cable Pin Assignment.....	6
8. EDID Management.....	7
9. Web GUI User Guide.....	9
10. RS-232 Control Command.....	16
11. Application Example.....	21

1. Introduction

The 18Gbps 4x4 HDMI Matrix can connect four HDMI sources to eight displays. It features four HDMI outputs and each HDMI output is mirrored to provide a CAT-Cable output which runs simultaneously. It supports the transmission of video (resolution is up to 1080p Full HD and 4Kx2K@60Hz 4:4:4) and supports HD digital audio formats such as LPCM 7.1CH, Dolby TrueHD, Dolby Digital Plus and DTS-HD Master Audio. Connect a CAT Receiver to each of the CAT-Cable outputs to extend the HDMI signal up to 230ft/70m for multi-room connectivity. Each HDMI output supports 4K2K to 1080P downscaler independently. The product supports control via front panel buttons, IR remote, RS-232, LAN, and Web GUI.

2. Features

- ☆ HDMI 2.0b and HDCP 2.2/1.x compliant
- ☆ Video resolution up to 4K2K@60Hz (YUV 4:4:4) on all HDMI & CAT ports
- ☆ 4 HDMI inputs, 4 HDMI & CAT mirrored outputs
- ☆ HDMI ports support 18Gbps lossless uncompressed video bandwidth
- ☆ Support 4K->1080P Down Scaler for each output port
- ☆ HDR, HDR10, HDR10+, Dolby Vision, HLG are supported
- ☆ CAT output can extend the transmission distance up to 230ft/70m via a single CAT6 cable
- ☆ HDMI audio pass-through up to 7.1CH HD audio (LPCM, Dolby TrueHD and DTS-HD Master Audio)
- ☆ Advanced EDID management and CEC control are supported
- ☆ 12V POC on all CAT ports
- ☆ Control via front panel buttons, IR remote, RS-232, LAN and Web GUI

3. Package Contents

- ① 1 x 18Gbps 4x4 HDMI Matrix
- ② 4 x CAT Receiver
- ③ 1 x Matrix IR Remote
- ④ 1 x 12V2.5A Power Supply
- ⑤ 1 x RS-232 serial Cable (1.5 meters, male to female head)
- ⑥ 1 x 3-pin Phoenix Connector
- ⑦ 4 x IR Blaster Cable (1.5 meters)
- ⑧ 4 x IR Receiver Cable (1.5 meters)
- ⑨ 10 x Mounting Ear (Matrix and Receiver)
- ⑩ 1x User Manual

4. Specifications

Technical	
HDMI Compliance	HDMI 2.0b
HDCP Compliance	HDCP 2.2/1.x
Video Bandwidth	18Gbps
Video Resolution	Up to 4K2K@50/60Hz (4:4:4)
Color Space	RGB 4:4:4, YCbCr 4:4:4/4:2:2/4:2:0
Color Depth	8-bit, 10-bit, 12-bit (1080p@60Hz) 8-bit (4K2K@60Hz YUV4:4:4) 8-bit, 10-bit, 12-bit (4K2K@60Hz YCbCr 4:2:2/4:2:0)
HDR	HDR10, HDR10+, Dolby Vision, HLG
HDMI Audio Formats	LPCM 2.0/2.1/5.1/6.1/7.1, Dolby Digital, Dolby TrueHD, Dolby Digital Plus (DD+), DTS-ES, DTS HD Master, DTS HD-HRA, DTS-X
Transmission Distance	230ft / 70m (via a single CAT6 cable)
ESD Protection	Human-body Model: ±8kV (Air-gap discharge) , ±4kV (Contact discharge)

Connection			
Matrix	Inputs: 4 x HDMI Type A [19-pin female] Outputs: 4 x HDMI Type A [19-pin female] 4 x CAT port [RJ45] 4 x IR OUT [3.5mm Stereo Mini-jack] Controls: 1 x TCP/IP [RJ45] 1 x RS-232 [3-pin phoenix connector]		
CAT Receiver	Inputs: 1x IR IN [3.5mm Stereo Mini-jack] 1x CAT port [RJ45] Output: 1x HDMI Type A [19-pin female] Control: 1x SERVICE [Micro USB, Update port]		
Mechanical			
Housing	Metal Enclosure		
Color	Black		
Dimensions	Matrix: 320mm (W) × 100mm (D) × 36mm (H) Receiver: 61mm (W) x 88mm (D) x 18mm (H)		
Weight	Matrix: 915g, Receiver: 155g		
Power Supply	Input: AC 90 - 260V 50/60Hz Output: DC 12V/2.5A (US/EU standards, CE/FCC/UL certified)		
Power Consumption	19.68W (Max)		
Operating Temperature	0°C ~ 40°C / 32°F ~ 104°F		
Storage Temperature	-20°C ~ 60°C / -4°F ~ 140°F		
Relative Humidity	20~90% RH (non-condensing)		
Resolution / Cable length	4K60 - Feet / Meters	4K30 - Feet / Meters	1080P60 - Feet / Meters
HDMI IN / OUT	16ft / 5M	32ft / 10M	50ft / 15M
The use of "Premium High Speed HDMI" cable is highly recommended.			

5. Operation Controls and Functions

5.1 Matrix Panel

Front Panel

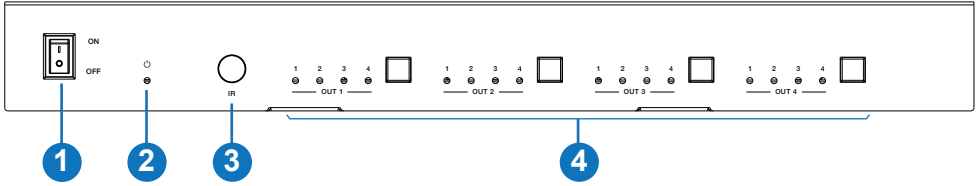

NO.	Name	Function Description
1	Power switch	Press the switch to power on/off the Matrix.
2	Power LED	The LED will illuminate in green when the Matrix is working normally, and red when the Matrix is on standby.
3	IR Window	IR receiver window, it only receives the IR remote signal from this Matrix.
4	OUT 1-4 buttons & Source LED 1~4	Press the OUT 1/2/3/4 button to circularly select HDMI source signal for the corresponding output port, then the corresponding source LED will be on.

Rear Panel

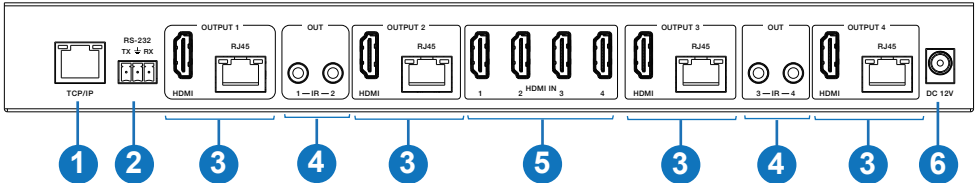

No.	Name	Function Description
1	TCP/IP port	The link port for TCP/IP control. Connect to an active Ethernet link with an RJ45 cable.
2	RS-232 port	RS-232 command control port. Connect to a PC or control system with a D-Sub 9-pin cable to control the Matrix.
3	OUTPUT 1-4 ports	HDMI output ports, connect to HDMI display devices such as TV or monitor with HDMI cable. CAT mirrored output ports, connect to CAT Receivers with CAT cable.
4	IR OUT 1-4 ports	Connect to IR blaster cable, the IR signal is from the "IR IN" port of the CAT Receiver.
5	HDMI IN 1-4 ports	HDMI signal input ports, connect to HDMI source device such as DVD or PS4 with HDMI cable.
6	DC 12V	DC 12V power supply port.

5.2 CAT Receiver Panel

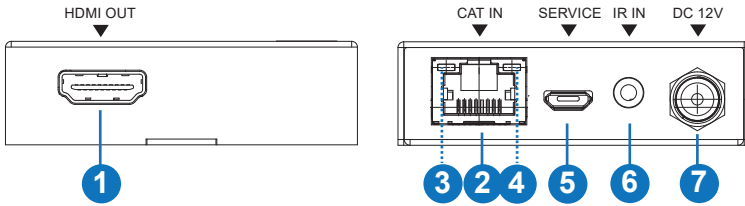

No.	Name	Function Description
1	HDMI OUT	HDMI output port, connect to HDMI display device such as TV or Projector with an HDMI cable.
2	CAT IN	Connect to the CAT OUTPUT port on the Matrix with a CAT cable.
3	Power Indicator Lamp (Green)	When the receiver is powered on, the power indicator lamp will be on.
4	Data signal Indicator Lamp (Orange)	When there is signal transmission between the Matrix and the receiver, the lamp will be on.
5	SERVICE port	Used for firmware update.
6	IR IN	Connect to the IR Receiver cable. The IR signal will send to the IR OUT port of the Matrix.
7	DC 12V	Plug DC 12V/1A power supply into the unit and connect the adapter to an AC outlet. (Note: The CAT receiver also can be powered by the Matrix via a CAT cable.)

6. IR Remote

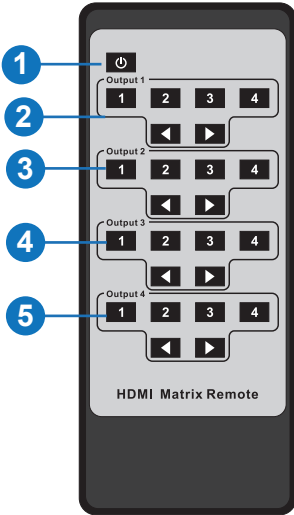

- ① **Power on or Standby:** Power on the Matrix or set it to standby mode.
 - ② **Output 1:** Press 1\2\3\4 button to select input source to HDMI OUTPUT 1.
 - ③ **Output 2:** Press 1\2\3\4 button to select input source to HDMI OUTPUT 2.
 - ④ **Output 3:** Press 1\2\3\4 button to select input source to HDMI OUTPUT 3.
 - ⑤ **Output 4:** Press 1\2\3\4 button to select input source to HDMI OUTPUT 4.
- ◀ ▶ : Select the last or next input source button.

7. IR Cable Pin Assignment



IR RECEIVER

IR BLASTER

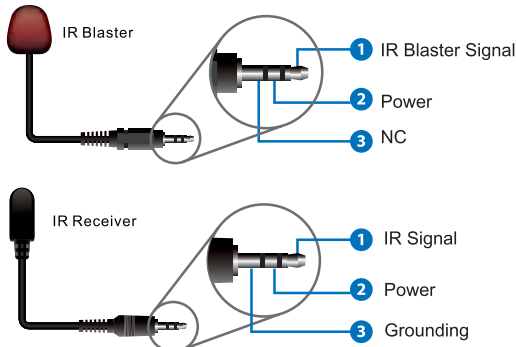

8. EDID Management

This Matrix has 21 factory defined EDID settings, 2 user-defined EDID modes and 8 copy EDID modes. You can select defined EDID mode or copy EDID mode to input port through RS-232 control or Web GUI.

RS-232 control operation: Connect the Matrix to PC with a serial cable, then open a Serial Command tool on PC to send ASCII command “s edid in x from z!” to set EDID. For details, please refer to “EDID Setting” in the ASCII command list of “10. RS-232 Control Command”.

Web GUI Operation: Please check the EDID management in the “Input page” of “9. Web GUI User Guide”.

The screenshot shows the Web GUI for an HDMI Matrix. The top navigation bar includes the HDMI logo, the device name '18Gbps 4x4 HDMI & Matrix', and user controls for 'Admin', 'Log out', and 'Power on'. A left sidebar contains a menu with categories: Status, Video, Input, Output, CEC, Network, and System. The main content area is titled 'Input Setting' and features a table with the following data:

Inputs	Active	Name	EDID
HDMI 1	<input checked="" type="radio"/>	Input1	4K2K60_444_Dolby/DTS 5.1 HDR
HDMI 2	<input checked="" type="radio"/>	Input2	4K2K60_444_Dolby/DTS 5.1 HDR
HDMI 3	<input checked="" type="radio"/>	Input3	4K2K60_444_Dolby/DTS 5.1 HDR
HDMI 4	<input checked="" type="radio"/>	Input4	4K2K60_444_Dolby/DTS 5.1 HDR

Below the table, there are two sections for EDID management:

- Load EDID to user memory:** Includes a 'Select EDID File:' field with a 'Browse' button, a 'Select Destination:' dropdown menu set to 'User Define1', and an 'Upload' button.
- DownLoad EDID to your computer:** Includes a 'Select EDID File:' dropdown menu set to 'HDMI IN1' and a 'Download' button.

The defined EDID setting list of the product is shown as below:

EDID Mode	EDID Description
1	1080P, Stereo Audio 2.0
2	1080P, Dolby/DTS 5.1
3	1080P, HD Audio 7.1
4	1080I, Stereo Audio 2.0
5	1080I, Dolby/DTS 5.1
6	1080I, HD Audio 7.1
7	3D, Stereo Audio 2.0
8	3D, Dolby/DTS 5.1
9	3D, HD Audio 7.1
10	4K2K30_444, Stereo Audio 2.0
11	4K2K30_444, Dolby/DTS 5.1
12	4K2K30_444, HD Audio 7.1
13	4K2K60_420, Stereo Audio 2.0
14	4K2K60_420, Dolby/DTS 5.1
15	4K2K60_420, HD Audio 7.1
16	4K2K60_444, Stereo Audio 2.0
17	4K2K60_444, Dolby/DTS 5.1
18	4K2K60_444, HD Audio 7.1
19	4K2K60, Stereo Audio 2.0 HDR
20	4K2K60, Dolby/DTS 5.1 HDR
21	4K2K60, HD Audio 7.1HDR
22	User Define1
23	User Define2
24	COPY_FROM_HDMI 1
25	COPY_FROM_HDMI 2
26	COPY_FROM_HDMI 3
27	COPY_FROM_HDMI 4
28	COPY_FROM_CAT 1
29	COPY_FROM_CAT 2
30	COPY_FROM_CAT 3
31	COPY_FROM_CAT 4

9. Web GUI User Guide

The Matrix can be controlled by Web GUI. The operation method is shown as below:

Step 1: Get the current IP Address.

The default IP address is 192.168.1.100. You can get the current Matrix IP address via RS-232 control. Send the ASCII command "r ipconfig!" through a Serial Command tool, then you'll get the feedback information as shown below:

```
IP Mode: DHCP
IP: 192.168.2.209
Subnet Mask: 255.255.255.0
Gateway: 192.168.2.1
TCP/IP port: 8000
Telnet port: 23
Mac address: 6C:DF:FB:07:1C:E2
```

IP: 192.168.2.209 in the above figure is the current Matrix IP address (this IP address is variable, depending on what the specific machine returns).

For the details of RS-232 control, please refer to "10. RS-232 Control Command".

Step 2: Connect the TCP/IP port of the Matrix to a PC with an UTP cable (as shown in the following figure), and set the IP address of the PC to be in the same network segment with the Matrix.

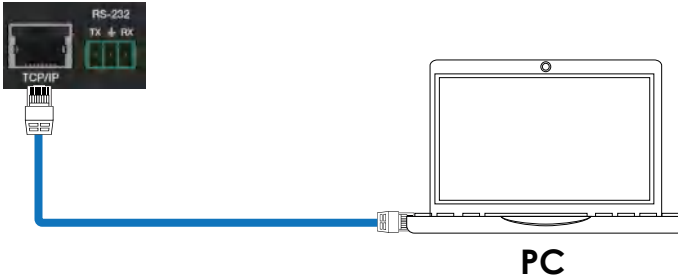

Step 3: Input the current IP address of Matrix into your browser on the PC to enter Web GUI page.



After entering the Web GUI page, there will be a Login page, as shown below:



Select the Username from the list and enter the password. The default passwords are:

Username	User	Admin
Password	user	admin

After entering the password, click the “LOGIN” button and the following Status page will appear.

■ Status Page

The Status page provides basic information about the product model, installed firmware version and the network settings of the device.

Status	
Model	HDP-IMXB44H60
Firmware Version	V1.00.05/V1.04
Hostname	MHUB4K88PRO
IP Address	192.168.1.100
Subnet Mask	255.255.255.0
Gateway	192.168.0.1
MAC Address	6C:D:F:04:5F:5A

■ Video Page

Output	Input	Presets Name	Presets Set	Presets Save	Presets Clear
hdmioutput1 / catoutput1	Input2	preset1	Set	Save	Clear
hdmioutput2 / catoutput2	Input1	preset2	Set	Save	Clear
hdmioutput3 / catoutput3	Input2	preset3	Set	Save	Clear
hdmioutput4 / catoutput4	Input1	preset4	Set	Save	Clear

You can do the following operations on the Video page:

- ① **Output:** The current device's OUTPUT port. You can select signal source for it.
- ② **Input:** You can click the drop-down menu to select signal source for the corresponding OUTPUT port .
- ③ **Presets Name:** You can name the current scene with maximum length of 12 characters (Chinese name is unsupported).
- ④ **Presets Set:** You can restore the settings of the last saved audio-video matrix switching relationship.
- ⑤ **Presets Save:** You can save audio-video matrix switching relationship.
- ⑥ **Presets Clear:** You can clear the saved audio-video matrix switching relationship.

■ Input Page

Inputs	Active	Name	EDID
HDMI 1	<input checked="" type="radio"/>	Input1	4K2K60_444_Dolby/DTS 5.1 HDR
HDMI 2	<input checked="" type="radio"/>	Input2	4K2K60_444_Dolby/DTS 5.1 HDR
HDMI 3	<input checked="" type="radio"/>	Input3	4K2K60_444_Dolby/DTS 5.1 HDR
HDMI 4	<input checked="" type="radio"/>	Input4	4K2K60_444_Dolby/DTS 5.1 HDR

You can do the following operations on the Input page:

- ① **Inputs:** Input channel of the device.
- ② **Active:** It indicates whether the channel is connected to a signal source.
- ③ **Name:** The input channel's name. You can modify it by entering the corresponding name (max length: 12 characters) in the input box (Chinese name is unsupported).
- ④ **EDID:** You can set the current channel's EDID. The specific operation is as follows:

Set EDID for the User

Click the “Browse” button, then select the bin file. If you select the wrong EDID file, there will be a prompt, as shown in the following figure:

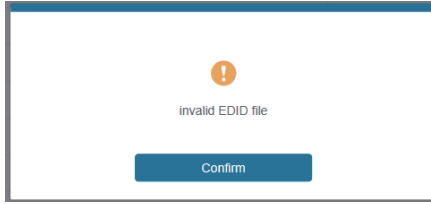

Make sure to select the correct file, then you can check the name of the selected file. Select “User 1” or “User 2”, then click “Upload”. After successful setting, it will prompt as follows:

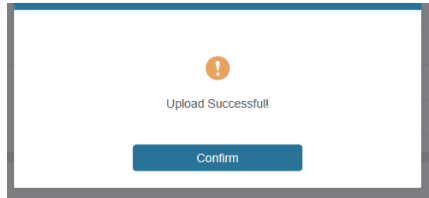

Download the EDID File for the Corresponding Input Channel

Click the drop-down box of “Select EDID File” to select the corresponding input channel. Then click “Download” to download the corresponding EDID file.

■ Output Page

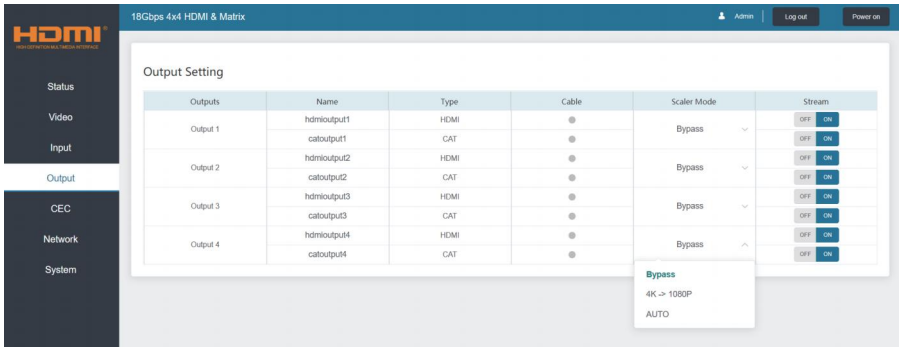

The screenshot shows the 'Output Setting' page for a 18Gbps 4x4 HDMI & Matrix device. The page has a sidebar on the left with navigation options: Status, Video, Input, Output (selected), CEC, Network, and System. The main content area displays a table of output settings. The table has columns for Outputs, Name, Type, Cable, Scaler Mode, and Stream. There are four output rows, each with two sub-rows for Name and Type. The Scaler Mode is set to 'Bypass' for all outputs. The Stream column has 'OFF' and 'ON' buttons for each output. A 'Bypass' dropdown menu is open, showing options: 4K -> 1080P and AUTO.

Outputs	Name	Type	Cable	Scaler Mode	Stream
Output 1	hdmioutput1	HDMI	●	Bypass	OFF ON
	catoutput1	CAT	●		OFF ON
Output 2	hdmioutput2	HDMI	●	Bypass	OFF ON
	catoutput2	CAT	●		OFF ON
Output 3	hdmioutput3	HDMI	●	Bypass	OFF ON
	catoutput3	CAT	●		OFF ON
Output 4	hdmioutput4	HDMI	●	Bypass	OFF ON
	catoutput4	CAT	●		OFF ON

You can do the following operations on the Output page:

- ① **Outputs:** Output channel of the device.
- ② **Name:** The current output channel's name. You can modify it by entering the corresponding name (max length: 12 characters) in the input box (Chinese name is unsupported).
- ③ **Type:** The current output channel's type (HDMI or CAT).
- ④ **Cable:** It indicates the connection status of output ports. When the output port is connected to the display, it shows green, otherwise, it shows gray.
- ⑤ **Scaler Mode:** Set the current output resolution mode.
- ⑥ **Stream:** Turn on/off the output stream.

■ CEC Page

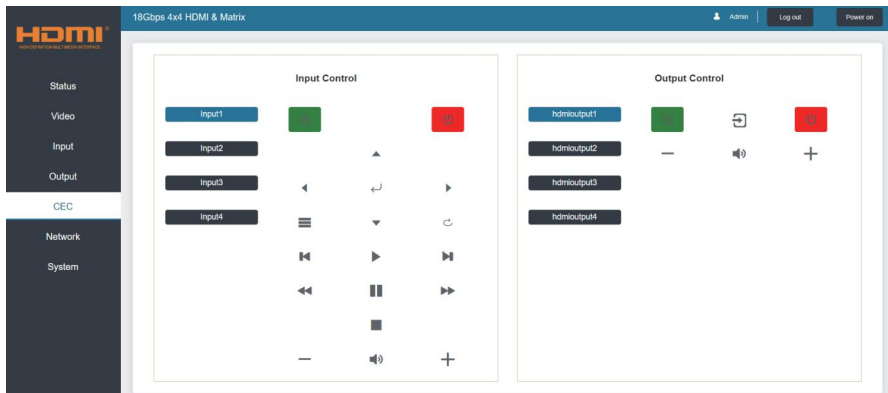

You can perform CEC management on this page:

- ① **Input Control:** You can control the operation of each input source by pressing the icons on the page. (You can control multiple inputs simultaneously.)
- ② **Output Control:** You can control the operation of each display, such as power on/off, volume +/-, active source switching. (You can control multiple outputs simultaneously.)

■ Network Page

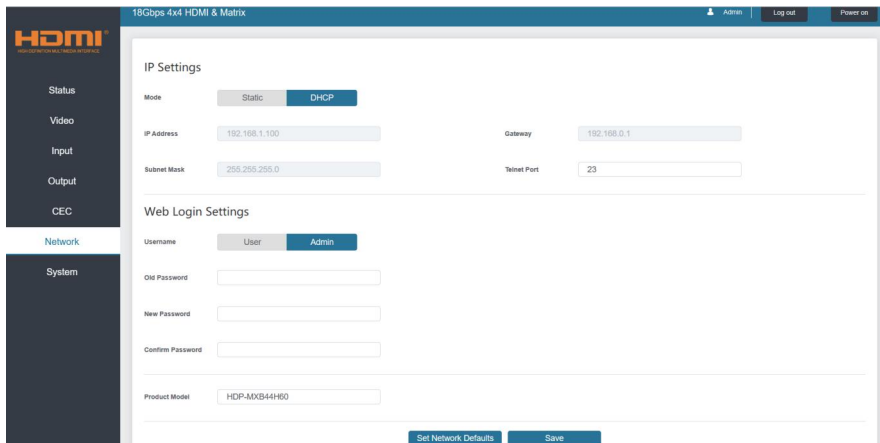

Set the Default Network

Click “Set Network Defaults” button, there will be a prompt, as shown in the following figure:

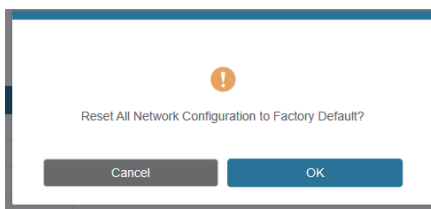

Click “OK” to search the IP Address again, as shown in the figure below.

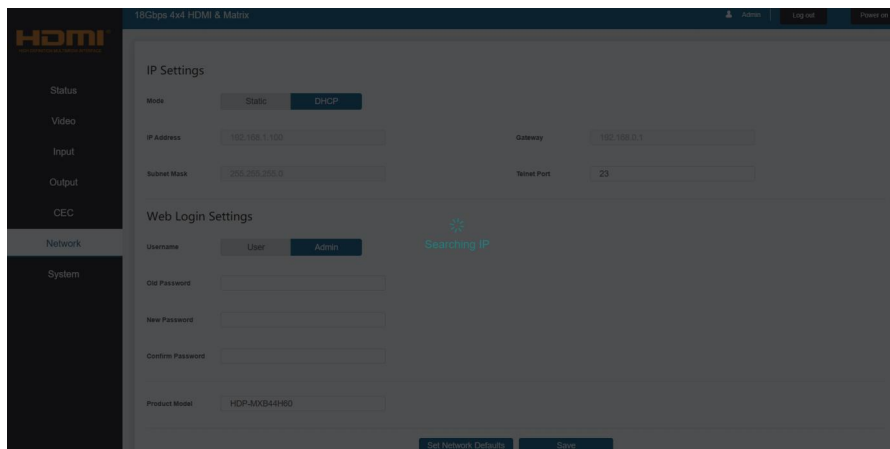

After searching is completed, it will switch to the login page, the default network setting is completed.

Modify User Password

Click the “User” button, enter the correct Old Password, New Password, and Confirm Password, then click “Save”. After successful modification, there will be a prompt, as shown in the following figure:

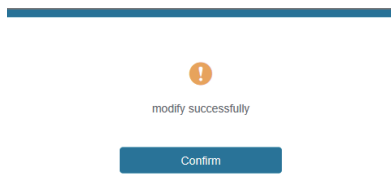

Note: Input rules for changing passwords:

- (1) The password can't be empty.
- (2) New Password can't be the same as Old Password.
- (3) New Password and Confirm Password must be the same.

Modify Network Setting

Modify the Mode/IP Address/Gateway/Subnet Mask/Telnet Port as required, click “Save” to save the settings, then it will come into effect.

After modification, if the Mode is “Static”, it will switch to the corresponding IP Address; if the Mode is “DHCP”, it will automatically search and switch to the IP Address assigned by the router.

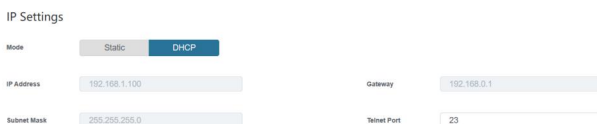

■ System Page

The screenshot shows the 'System Page' for an '18Gbps 4x4 HDMI & Matrix' device. The interface includes a sidebar with navigation options: Status, Video, Input, Output, CEC, Network, and System. The main content area is divided into several sections:

- Panel Lock:** A toggle switch currently set to 'OFF'.
- Beep:** A toggle switch currently set to 'ON'.
- Serial Baud Rate:** A selection menu with options: 4800, 9600, 19200, 38400, 57600, and 115200. The 115200 option is selected.
- Firmware Update:** A section with a 'Browse' button to select a file and an 'Update' button to complete the update.
- Factory Reset:** A 'Reset' button to restore factory defaults.
- Reboot:** A 'Reboot' button to restart the device.

- ① **Panel Lock:** Click to lock/unlock panel buttons. “On” indicates that panel buttons are unavailable; “Off” indicates panel buttons are available.
 - ② **Beep:** Click to turn on/off the beep.
 - ③ **Serial Baud Rate:** Click the value to set the Serial Baud Rate.
 - ④ **Firmware Update:** Click “Browse” to select the update file, then click “Update” to complete firmware update.
 - ⑤ **Factory Reset:** You can reset the machine to factory defaults by clicking “Reset”.
 - ⑥ **Reboot:** You can reboot the machine by clicking “Reboot”.
- Note:** After reset/reboot, it will switch to the login page.

10. RS-232 Control Command

The product also supports RS-232 control. You need a serial cable with RS-232 phoenix connector and RS-232 male head. The RS-232 phoenix connector is connected to the Matrix, and the RS-232 male head of the serial cable is connected to the RS-232 female head of an RS-232 to USB cable, while the USB head of the RS-232 to USB cable is connected to a PC. The connection method is as follows:

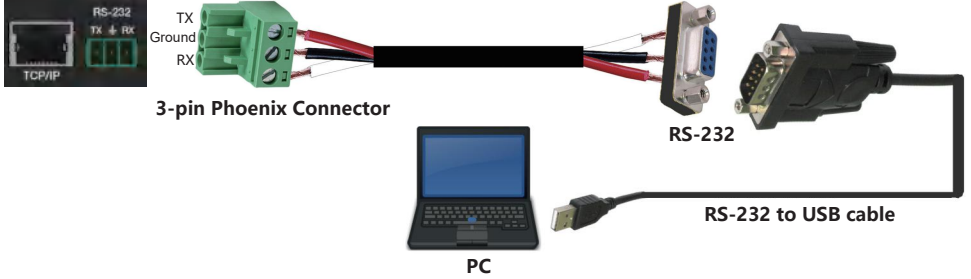

Then, open a Serial Command tool on PC to send ASCII command to control the Matrix. The ASCII command list about the product is shown as below.

ASCII Command				
Serial port protocol. Baud rate: 115200, Data bits: 8bit, Stop bits:1, Check bit: 0				
x - Parameter 1 y - Parameter 2 ! - Delimiter				
Command Code	Function Description	Example	Feedback	Default Setting
Power				
s power z!	Power on/off the device,z=0~1 (z=0 power off, z=1 power on)	s power 1!	Power on System Initializing... Initialization Finished! FW version x.xx.xx	power on
r power!	Get current power state	r power!	power on/power off	
s reboot!	Reboot the device	s reboot!	Reboot... System Initializing... Initialization Finished! FW version x.xx.xx	
System Setup				
help!	List all commands	help!		
r type!	Get device model	r type!	HDP-MXB44D70	
r status!	Get device current status	r status!	Get the unit all status: power, beep, lock, in/ out connection, video/ audio crosspoint, edid, scaler,hdcv, network status	
r fw version!	Get Firmware version	r fw version!	MCU BOOT:Vx.xx.xx MCU APP :Vx.xx.xx WEB GUI :Vx.xx	

Command Code	Function Description	Example	Feedback	Default Setting
r link in x!	Get the connection status of the x input port, x=0~4(0=all)	r link in 1!	hdmi input 1: connect	
r link out y!	Get the connection status of the y output port, y=0~4(0=all)	r link out 1!	hdmi output 1: connect	
s reset!	Reset to factory defaults	s reset!	Reset to factory defaults System Initializing... Initialization Finished! FW version x.xx.xx	
s beep z!	Enable/Disable buzzer function, z=0~1(z=0 beep off, z=1 beep on)	s beep 1!	beep on beep off	beep on
r beep!	Get buzzer state	r beep!	beep on / beep off	
s lock z!	Lock/Unlock front panel button, z=0~1 (z=0 lock off,z=1 lock on)	s lock 1!	panel button lock on panel button lock off	panel button lock off
r lock!	Get panel button lock state	r lock!	panel button lock on/off	
s save preset z!	Save switch state between all output port and the input port to preset z, z=1~4	s save preset 1!	save to preset 1	
s recall preset z!	Call saved preset z scenarios, z=1~4	s recall preset 1!	recall from preset 1	
s clear preset z!	Clear stored preset z scenarios, z=1~4	s clear preset 1!	clear preset 1	
r preset z!	Get preset z information, z=1~4	r preset 1!	video/audio crosspoint	
s baud rate xxx!	Set the serial port baud rate of RS02 module, z=(115200,57600,38400,19200,9600,4800)	s baud rate 115200!	Baudrate:115200	
r baud rate!	Get the serial port baud rate of RS02 module	r baud rate!	Baudrate:115200	
s id z!	Set the control ID of the product, z=000~999	s id 888!	id 888	0
Output Setting				
s in x av out y!	Set input x to output y, x=1~4, y=0~4(0=all)	s in 1 av out 2!	input 1 -> output 2	ptp
r av out y!	Get output y signal status y=0~4(0=all)	r av out 0!	input 1 -> output 1 input 2 -> output 2 input 3 -> output 3 input 4 -> output 4	
s hdmi y stream z!	Set hdmi output y stream on/off, y=0~4(0=all) z=0~1(0:disable,1:enable)	s hdmi 1 stream 1! s hdmi 0 stream 1!	enable hdmi output 1 stream disable hdmi output 1 stream enable hdmi all outputs stream disable hdmi all outputs stream	enable
r hdmi y stream!	Get hdmi output y stream status, y=0~4(0=all)	r hdmi 1 stream!	enable hdmi output 1 stream	
s cat y stream z!	Set cat output y stream on/off, y=0~4(0=all) z=0~1(0:disable,1:enable)	s cat 1 stream 1! s cat 0 stream 1!	enable cat output 1 stream disable cat output 1 stream enable cat all outputs stream disable cat all outputs stream	enable

Command Code	Function Description	Example	Feedback	Default Setting
r cat y stream!	Get cat output y stream status, y=0~4(0=all)	r cat 1 stream!	enable cat output 1 stream	
s hdmi y scaler z!	Set hdmi output y port output scaler mode, y=0~4(0=all), z=1~3(1=bypass,2=4k->1080p,3=Auto)	s hdmi 1 scaler 1! s hdmi 0 scaler 1!	hdmi output 1 set to bypass mode hdmi all outputs set to bypass mode	hdmi all outputs set to bypass mode
r hdmi y scaler!	Get hdmi output y port output mode y=0~4(0=all)	r hdmi 1 scaler!	hdmi output 1 set to bypass mode	
EDID Setting				
s edid in x from z!	Set input x EDID from default EDID z, x=0~4(0=all),z=1~31 1, 1080p,Stereo Audio 2.0 2, 1080p,Dolby/DTS 5.1 3, 1080p,HD Audio 7.1 4, 1080i,Stereo Audio 2.0 5, 1080i,Dolby/DTS 5.1 6, 1080i,HD Audio 7.1 7, 3D,Stereo Audio 2.0 8, 3D,Dolby/DTS 5.1 9, 3D,HD Audio 7.1 10, 4K2K30_444,Stereo Audio 2.0 11, 4K2K30_444,Dolby/DTS 5.1 12, 4K2K30_444,HD Audio 7.1 13, 4K2K60_420,Stereo Audio 2.0 14, 4K2K60_420,Dolby/DTS 5.1 15, 4K2K60_420,HD Audio 7.1 16, 4K2K60_444,Stereo Audio 2.0 17, 4K2K60_444,Dolby/DTS 5.1 18, 4K2K60_444,HD Audio 7.1 19, 4K2K60_444,Stereo Audio 2.0 HDR 20, 4K2K60_444,Dolby/DTS 5.1 HDR 21, 4K2K60_444,HD Audio 7.1 HDR 22, User define1 23, User define2 24, copy from hdmi output 1 25, copy from hdmi output 2 26, copy from hdmi output 3 27, copy from hdmi output 4 28, copy from cat output 1 29, copy from cat output 2 30, copy from cat output 3 31, copy from cat output 4	s edid in 1 from 1! s edid in 0 from 1!	input 1 EDID:1080p, Stereo Audio 2.0 all inputs EDID:1080p, Stereo Audio 2.0	1080p, Stereo Audio 2.0
r edid in x!	Get EDID status of the input x, x=0~4(0=all input)	r edid in 0!	input1 EDID: 4K2K60_444,Stereo Audio 2.0 input2 EDID: 4K2K60_444,Stereo Audio 2.0 input3 EDID: 4K2K60_444,Stereo Audio 2.0 input4 EDID: 4K2K60_444,Stereo Audio 2.0	
r edid data hdmi y!	Get the EDID data of the hdmi output y port, y=1~4	r edid data hdmi 1!	EDID: 00 FF FF FF FF FF FF 00 hdmi output 1: disconnect	
CEC Setting				
s cec in x on!	set input x power on by CEC, x=0~4(0=all input)	s cec in 1 on!	input 1 power on	
s cec in x off!	set input x power off by CEC, x=0~4(0=all input)	s cec in 1 off!	input 1 power off	

Command Code	Function Description	Example	Feedback	Default Setting
s cec in x menu!	set input x open menu by CEC, x=0~4(0=all input)	s cec in 1 menu!	input 1 open menu	
s cec in x back!	set input x back operation by CEC, x=0~4(0=all input)	s cec in 1 back!	input 1 back operation	
s cec in x up!	set input x menu up operation by CEC, x=0~4(0=all input)	s cec in 1 up!	input 1 menu up operation	
s cec in x down!	set input x menu down operation by CEC, x=0~4(0=all input)	s cec in 1 down!	input 1 menu down operation	
s cec in x left!	set input x menu left operation by CEC, x=0~4(0=all input)	s cec in 1 left!	input 1 menu left operation	
s cec in x right!	set input x menu right operation by CEC, x=0~4(0=all input)	s cec in 1 right!	input 1 menu right operation	
s cec in x enter!	set input x menu enter operation by CEC, x=0~4(0=all input)	s cec in 1 enter!	input 1 menu enter operation	
s cec in x play!	set input x play by CEC, x=0~4(0=all input)	s cec in 1 play!	input 1 play operation	
s cec in x pause!	set input x pause by CEC, x=0~4(0=all input)	s cec in 1 pause!	input 1 pause operation	
s cec in x stop!	set input x stop by CEC, x=0~4(0=all input)	s cec in 1 stop!	input 1 stop operation	
s cec in x rew!	set input x rewind by CEC, x=0~4(0=all input)	s cec in 1 rew!	input 1 rewind operation	
s cec in x mute!	set input x volume mute by CEC, x=0~4(0=all input)	s cec in 1 mute!	input 1 volume mute	
s cec in x vol-!	set input x volume down by CEC, x=0~4(0=all input)	s cec in 1 vol-!	input 1 volume down	
s cec in x vol+!	set input x volume up by CEC, x=0~4(0=all input)	s cec in 1 vol+!	input 1 volume up	
s cec in x ff!	set input x fast forward by CEC, x=0~4(0=all input)	s cec in 1 ff!	input 1 fast forward operation	
s cec in x previous!	set input x previous by CEC, x=0~4(0=all input)	s cec in 1 previous!	input 1 previous operation	
s cec in x next!	set input x next by CEC, x=0~4(0=all input)	s cec in 1 next!	input 1 next operation	
s cec hdmi out y on!	set hdmi output y power on by CEC, y=0~4(0=all hdmi output)	s cec hdmi out 1 on!	hdmi output 1 power on	
s cec hdmi out y off!	set hdmi output y power off by CEC, y=0~4(0=all hdmi output)	s cec hdmi out 1 off!	hdmi output 1 power off	
s cec hdmi out y mute!	set hdmi output y volume mute by CEC, y=0~4(0=all hdmi output)	s cec hdmi out 1 mute!	hdmi output 1 volume mute	
s cec hdmi out y vol-!	set hdmi output y volume down by CEC, y=0~4(0=all output)	s cec hdmi out 1 vol-!	hdmi output 1 volume down	
s cec hdmi out y vol+!	set hdmi output y volume up by CEC, y=0~4(0=all output)	s cec hdmi out 1 vol+!	hdmi output 1 volume up	
s cec hdmi out y active!	set hdmi output y active source by CEC, y=0~4(0=all output)	s cec hdmi out 1 active!	hdmi output 1 active source	
Network Setting				
r ipconfig!	Get the Current IP Configuration	r ipconfig!	IP Mode: Static IP: 192.168.1.72 Subnet Mask: 255.255.255.0 Gateway: 192.168.1.1 TCP/IP port=8000 Telnet port=10 Mac address: 00:1C:91:03:80:01	

Command Code	Function Description	Example	Feedback	Default Setting
r mac addr!	Get network MAC address	r mac addr!	Mac address: 00:1C:91:03:80:01	
s ip mode z!	Set network IP mode to static IP or DHCP, z=0~1 (z=0 Static, z=1 DHCP)	s ip mode 0!	Set IP mode:Static (Please use "s net reboot!" command or repower device to apply new config!)	
r ip mode!	Get network IP mode	r ip mode!	IP Mode: Static	
s ip addr xxx.xxx.xxx.xxx!	Set network IP address	s ip addr 192.168.1.100!	Set IP address: 192.168.1.100 (Please use "s net reboot!" command or repower device to apply new config!) DHCP on, Device can't config static address, set DHCP off first.	
r ip addr!	Get network IP address	r ip addr!	IP:192.168.1.100	
s subnet xxx.xxx.xxx.xxx!	Set network subnet mask	s subnet 255.255.255.0!	Set subnet Mask address:255.255.255.0 (Please use "s net reboot!" command or repower device to apply new config!) DHCP on, Device can't config subnet mask, set DHCP off first.	
r subnet!	Get network subnet mask	r subnet!	Subnet Mask: 255.255.255.0	
s gateway xxx.xxx.xxx.xxx!	Set network gateway	s gateway 192.168.1.1!	Set gateway: 192.168.1.1 Please use "s net reboot!" command or repower device to apply new config! DHCP on, Device can't config gateway, set DHCP off first.	
r gateway!	Get network gateway	r gateway!	Gateway:192.168.1.1	
s tcp/ip port x!	Set network TCP/IP port (x=1~65535)	s tcp/ip port 8000!	Set TCP/IP port:8000	
r tcp/ip port!	Get network TCP/IP port	r tcp/ip port!	TCP/IP port:8000	
s telnet port x!	Set network telnet port (x=1~65535)	s telnet port 23!	Set Telnet port:23	
r telnet port!	Get network telnet port	r telnet port!	Telnet port:23	
s net reboot!	Reboot network modules	s net reboot!	Network reboot... IP Mode: Static IP: 192.168.1.72 Subnet Mask: 255.255.255.0 Gateway: 192.168.1.1 TCP/IP port=8000 Telnet port=10 Mac address: 00:1C:91:03:80:01	

11. Application Example

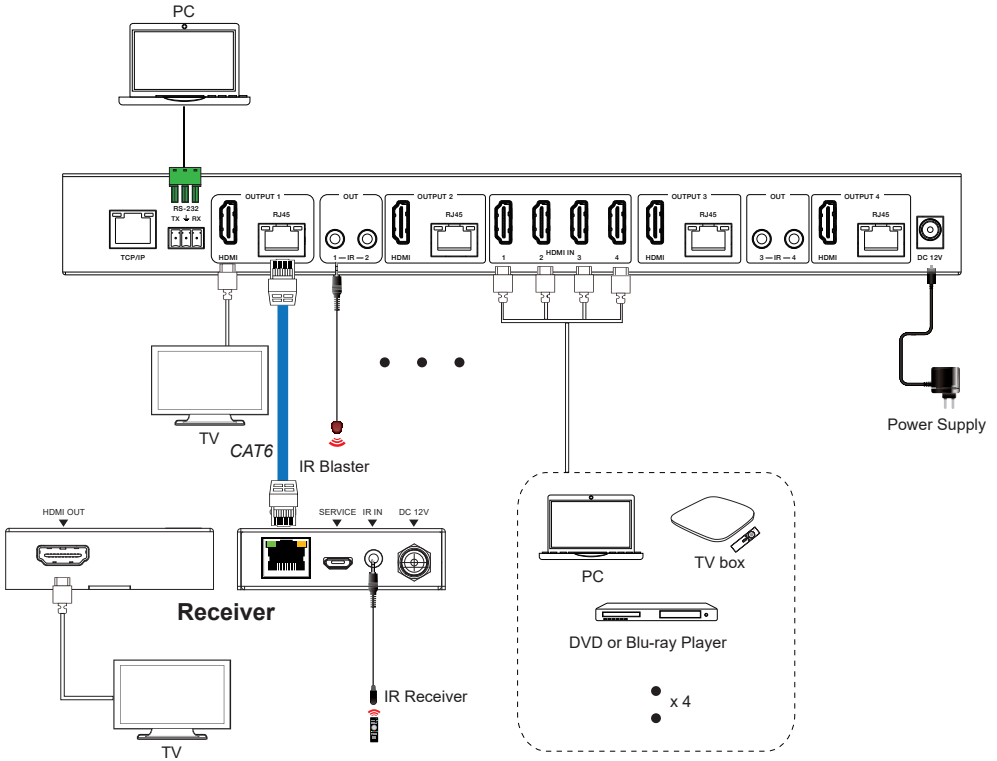

The terms HDMI and HDMI High-Definition Multimedia interface, and the HDMI Logo are trademarks or registered trademarks of HDMI Licensing LLC in the United States and other countries.